



# Damping technology

- Industrial shock absorbers PowerStop
- Profile dampers BasicStop

THE KNOW-HOW FACTORY

**THE KNOW-HOW FACTORY**

# ZIMMER GROUP

## COMMITTED TO OUR CUSTOMERS

**WE HAVE SUCCEEDED FOR YEARS BY OFFERING OUR CUSTOMERS INNOVATIVE AND INDIVIDUALIZED SOLUTIONS. ZIMMER HAS GROWN CONTINUOUSLY AND TODAY WE HAVE REACHED A NEW MILESTONE: THE ESTABLISHMENT OF THE KNOW-HOW FACTORY. IS THERE A SECRET TO OUR SUCCESS?**

**Foundation.** Excellent products and services have always been the foundation of our company's growth. Zimmer is a source of ingenious solutions and important technical innovations. This is why customers with high expectations for technology frequently find their way to us. When things get tricky, Zimmer Group is in its best form.

**Style.** We have an interdisciplinary approach to everything we do, resulting in refined process solutions in six technology fields. This applies not just to development but to production. Zimmer Group serves all industries and stands ready to resolve even the most unique and highly individualized problems. Worldwide.

**Motivation.** Customer orientation is perhaps the most important factor of our success. We are a service provider in the complete sense of the word. With Zimmer Group, our customers have a single, centralized contact for all of their needs. We approach each customer's situation with a high level of competence and a broad range of possible solutions.



# TECHNOLOGIES

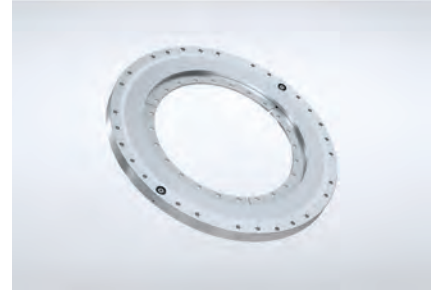
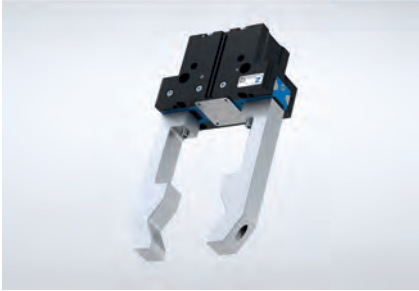

## HANDLING TECHNOLOGY

More than 30 years of experience and industry knowledge: our pneumatic, hydraulic and electrical handling components and systems are global leaders.

**Components.** More than 2,000 standardized grippers, pivot units, robot accessories and much more. We offer a complete selection of technologically superior products that are ready for rapid delivery.

**Semi-standard.** Our modular approach to design enables custom configurations and high rates of innovation for process automation.

## DAMPING TECHNOLOGY

Industrial damping technology and Soft Close products exemplify the innovation and pioneering spirit of the Know-How Factory.

### Industrial damping technology.

Whether standard or customized solutions, our products stand for the highest cycle rates and maximum energy absorption with minimal space requirements.

**Soft Close.** Development and production of superior quality pneumatic and fluid dampers. High-volume production ensures rapid delivery.

**OEM and direct.** Whether they need components, returning mechanisms or complete production lines—we are the trusted partner of many prestigious customers.

## LINEAR TECHNOLOGY

We develop linear technology components and systems that are individually adapted to our customers' needs.

### Clamping and braking elements.

We offer you more than 4000 types for profiled and round rails as well as for a variety of guide systems from all manufacturers. It makes no difference whether you prefer manual, pneumatic, electric or hydraulic drive.

**Flexibility.** Our clamping and braking elements ensure that movable components such as Z-axes or machining tables maintain a fixed position and that machines and systems come to a stop as quickly as possible in an emergency.

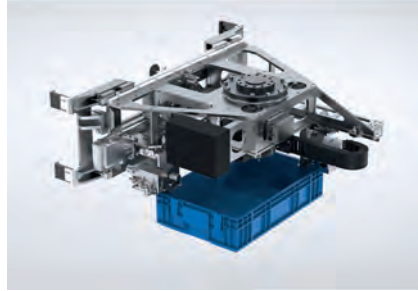
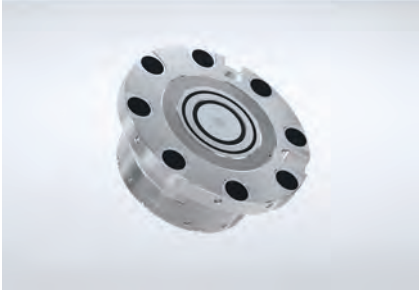

## MACHINE TECHNOLOGY

Zimmer Group develops innovative metal, wood and composite material processing tool systems for all industries. Numerous customers choose us as their systems and innovation partner.

**Knowledge and experience.** Industry knowledge and a decades-long development partnership for exchangeable assemblies, tool interfaces and tool systems predestine us for new challenges around the world.

**Components.** We deliver numerous standard components from stock and develop innovative, customized systems for OEM and end customers—far beyond the metal and wood processing industries.

**Variety.** Whether you have machining centers, lathes or flexible production cells, the power tools, holders, assemblies and drilling heads of Zimmer Group are ready for action.

## SYSTEM TECHNOLOGY

Zimmer Group is one of world's leading specialists in the development of customized systems solutions.

**Customized.** A team made up of more than 20 experienced designers and project engineers develop and produce customized solutions for special tasks in close collaboration with end customers and system integrators. It doesn't matter if it is a simple gripper and handling solutions or a complex system solution.

**Solutions.** These system solutions are used in many industries, from mechanical engineering to the automotive and supplier industries and from the plastics engineering, electronics and consumer goods industries all the way to foundries. The Know-how Factory helps countless companies to thrive competitively by increasing automation efficiency.

## PROCESS TECHNOLOGY

Maximum efficiency is essential for systems and components used in process technology. High-level custom solutions are our trademark.

**A rich reservoir of experience.** Our know-how ranges from the development of materials, processes and tools through product design to production of series products.

**Vertical integration.** The Zimmer Group pairs these capabilities with flexibility, quality and precision, even when making custom products.

**Series production.** We manufacture demanding products out of metal (MIM), elastomers and plastics with flexibility and speed.









# COMPLETE PROGRAM IN OVERVIEW

## INDUSTRIAL DAMPING TECHNOLOGY



### INTRODUCTION INTRODUCTION

■ Page 10



### PRODUCT FINDER A HIGH-PERFORMANCE TOOL

■ Page 11



### OVERVIEW PRODUCT PORTFOLIO

■ Page 12

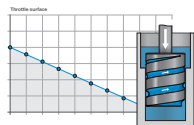

### INDUSTRIAL SHOCK AB- SORBER POWERSTOP TECHNICAL INFORMATION

■ Page 15



### INDUSTRIAL SHOCK AB- SORBER POWERSTOP COMPONENTS

■ Page 16 - 97



### INDUSTRIAL SHOCK AB- SORBER POWERSTOP CUSTOM SOLUTIONS AND SYSTEMS

■ Page 98 - 99



### INDUSTRIAL SHOCK AB- SORBER POWERSTOP PRESS

■ Page 100 - 101

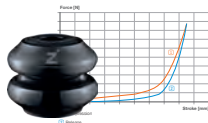

### PROFILE DAMPERS BASICSTOP TECHNICAL INFORMATION

■ Page 103 - 105



### PROFILE DAMPERS BASICSTOP COMPONENTS

■ Page 106 - 117

$$W_1 = \frac{1}{2} \cdot J \cdot \omega_1^2$$

$$W_2 = m \cdot g \cdot \frac{L}{R} \cdot s - \frac{M}{R} \cdot s$$

$$v_A = \omega_1 \cdot R = v_1 \cdot \frac{R}{L}$$

### GENERAL CALCULATION

■ Page 119 - 128

### PLEASE MARK:



### GENERAL CHECKLIST

■ Page 130 - 131



### GENERAL TIPS AND TRICKS

■ Page 132 - 135

# INTRODUCTION

## INTRODUCTION

### Use and advantages of shock absorbers

Machines carry out increasingly complex tasks today. The systems are also pushed to their limits in order to increase productivity and profitability. For the machinery this means that, in addition to the number of moving parts, their velocities and thus their kinetic energy also increase. However, in order to avoid collisions, high impact forces and strong vibrations, which could lead to damage and consequently to the reduction of the service life, the surplus energy must be removed from the system. The solution lies in the use of energy dissipation, in the context of which kinetic energy is transformed into thermal energy (heat) through friction, which is better known under the term damping.

In order to reduce wear and increase the effectiveness of a machine during a process, friction is reduced to a minimum with the help of tribological (friction technology) knowledge. Energy and raw material resources can in this way be saved in the course of cost reduction and environmental protection. However, this has the consequence that special components, such as the products of the Zimmer Group from the Industrial Damping Technology division, are required to remove kinetic energy in a targeted fashion at those points and in those situations at which damage could be caused. In the case of shock absorption, this serves to brake and stop moving masses prior to end stops.

This is how the shock absorbers from Zimmer Group provide the following advantages for your machines and systems:

- ▶ Increased machine service life thanks to a reduction of damaging force peaks and vibrations, which reduces downtimes and maintenance costs
- ▶ Increased operational speeds of the machine
- ▶ Increased safety for collisions and stops caused by emergencies
- ▶ Increased productivity and efficiency of the machinery
- ▶ Reduction of noise exposure by reducing noise emissions in production
- ▶ Highly focused damping with positioning to an end stop (PowerStop industrial shock absorber)

The integration of the shock absorbers results in safer operation due to a reduction of loads with a simultaneous increase in machinery utilization. Dynamics and velocities can be controlled with the help of the shock absorbers.



### Operating modes of shock absorbers: Continuous operation and emergency stop operation

There are two different operating modes for shock absorbers. Continuous operation represents regular loading of the shock absorber with a certain number of cycles per unit of time. This results in the heating up of the shock absorber, which results in a certain operating temperature prevailing from the thermal balance between heat absorption due to damping and heat dissipation to the surroundings.

With emergency stop operation, the shock absorber is only used in exceptional situations or emergencies, e.g. a failure of the machine control system. In this case there is no number of cycles per time unit, but instead, in the best case scenario the load does not even occur, or comes at irregular or unpredictable intervals. Some shock absorbers are conceived such that they can absorb even more energy per stroke in emergency stop operation than they can in continuous operation.

# PRODUCT FINDER

## A HIGH-PERFORMANCE TOOL



### Calculate and select shock absorbers more quickly

Users receive a high-performance tool that allows them to make well-founded selection decisions quickly and combines calculation, selection guide and configurator functions in one tool.

### Convenient calculation delivers fast results

A choice between a large number of different load cases appropriate to the case can be selected very easily. The procedure is very simple: All one has to do is select the right load case and then specify the required values to obtain a reliable result.

### Clearly arranged selection guide

The available dampers that meet these specifications are shown to the user in an overview table. The energy absorption for each damper is individually calculated in the table and its load is displayed.

### Advanced search using a filter

Using filters, additional marginal conditions can be entered. These include especially high or low temperatures, use in the pressure chamber, contaminated environments or large angles for the impact of the load. The software returns suitable versions and necessary accessories or equipment options based on the selected filter.

### Appealing solution, available as a mobile application

Since the calculation program is available online, customers do not have to install any software and can access it using any computer or laptop, as well as with any smartphone or tablet.

# OVERVIEW

## PRODUCT PORTFOLIO

### ▶ INDUSTRIAL SHOCK ABSORBER



<b>Brand:</b>	PowerStop
<b>Damping type:</b>	Hydraulic
<b>Know-how:</b>	Spiral groove technology Oil reserve Bio-oil
<b>Series:</b>	Mini Energy – The slender Standard Energy – The economical High Energy – The powerful Adjustable Energy – The Adjustable
<b>Thread diameter:</b>	M4 – M36
<b>Degree of hardness (speed range):</b>	Hard (0.1 - 1.2 m/s; Adjustable Energy: 0.1 - 5 m/s) Medium (0.8 - 2.2 m/s) Soft (1.8 - 3.5 m/s) Supersoft (3 - 5 m/s)

### ▶ PROFILE DAMPER



<b>Brand:</b>	BasicStop
<b>Damping type:</b>	Viscoelastic
<b>Know-how:</b>	Material TPC Conditioning process Structure design
<b>Series:</b>	Axial Standard – Axial design Axial Advanced – Axial design for heavy load Radial Standard – Radial design
<b>Degree of hardness (Shore hardness):</b>	Hard H (Shore 55D) Medium M (Shore 40D)

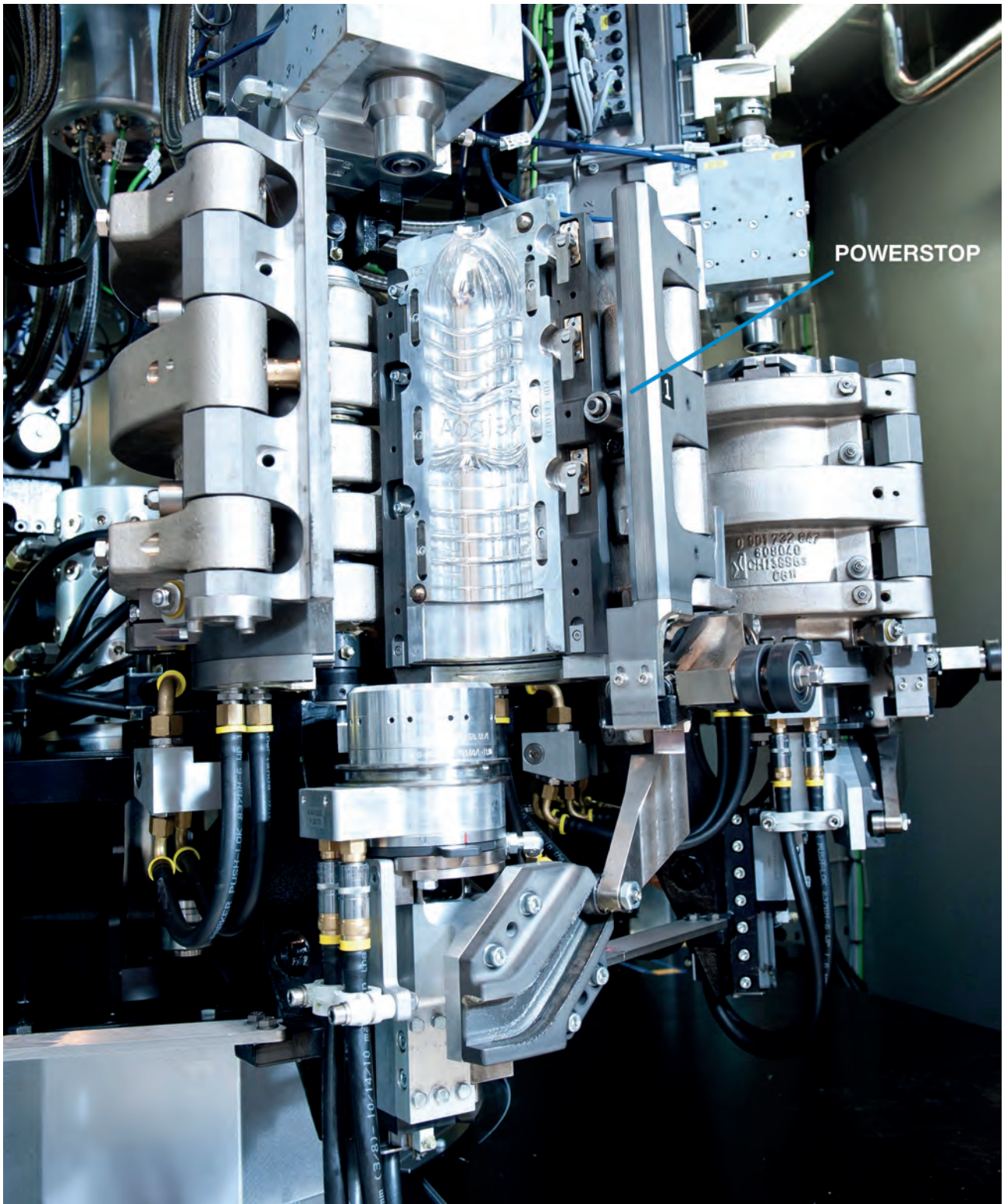

- ▶ Gentle closing of the stretch-blow molds by PowerStop HighEnergy dampers in Krones systems for the manufacture of PET bottles



# INDUSTRIAL SHOCK ABSORBERS

## POWERSTOP



# INDUSTRIAL SHOCK ABSORBERS POWERSTOP

## THE SERIES AT A GLANCE

### ▶ MINI ENERGY

#### The slender

The Mini Energy provides a high rate of energy absorption when it comes to precision damping in miniature areas. Also installed in the cylinder for even greater space savings.

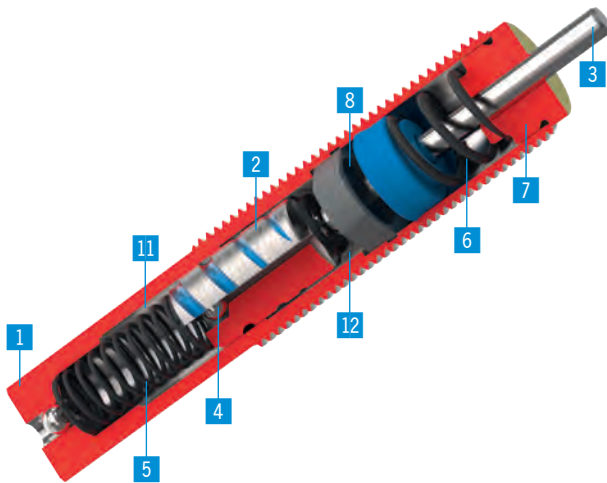

#### PRODUCT ADVANTAGES

- ▶ Highest performance in a minimal space
- ▶ Integrated oil volume reservoir
- ▶ Increased guide length

Series	▶ Technical data
Series	<b>Mini Energy</b>
Thread	M4 - M6
Pressure max. (abs.) [bar]	10
Stroke variant	Standard stroke
Protection	no protection, wiper (NBR)
Volume compensation	Spring

### ▶ STANDARD ENERGY

#### The economical

The number one among standard dampers. Efficient damping at common energy absorption levels. This makes the Standard Energy series the winner in price/performance value.

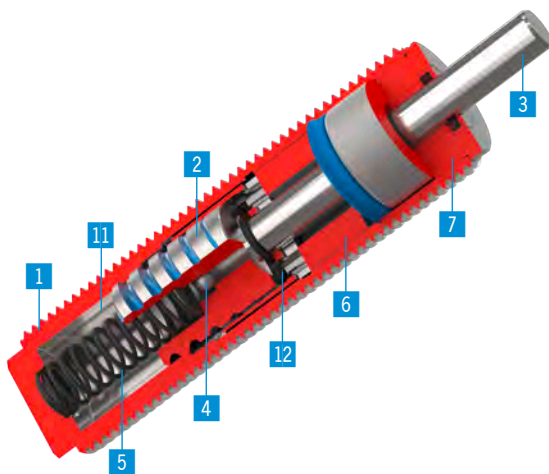

#### PRODUCT ADVANTAGES

- ▶ Price/performance winner
- ▶ Low-vibration damping thanks to spiral groove
- ▶ Low counterforce

Series	▶ Technical data
Series	<b>Standard Energy</b>
Thread	M8 - M36
Pressure max. (abs.) [bar]	1
Stroke variant	Standard stroke
Protection	no protection, wiper (NBR), felt ring, bellow (TPE)
Volume compensation	Cellular rubber

**1** Housing (stainless steel)

**2** Damping piston with spiral groove

**3** Piston rod (stainless steel)

**4** Return valve

**5** Return spring

**6** Volume compensation / Seal



## ▶ HIGH ENERGY

### The powerful

The high-end damper for the highest demands. Thanks to the spiral groove in combination with the pressure sleeve and the oil reserve, the High Energy series achieves a number of cycles that exceeds everything else on the market, with extreme energy absorption levels. All this with minimal space requirements.

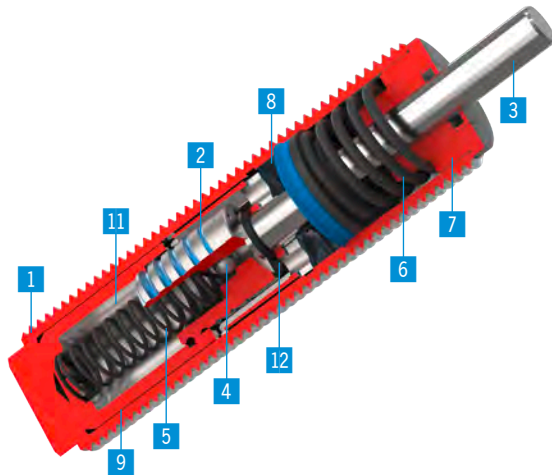

### PRODUCT ADVANTAGES

- ▶ For the highest demands and maximum energy absorption
- ▶ Integrated oil reserve
- ▶ Hardened and precision-ground guide
- ▶ Cycle counts that outperform everything else on the market

Series	▶ Technical data
Series	<b>High Energy</b>
Thread	M8 - M36
Pressure max. (abs.) [bar]	10
Stroke variant	Standard stroke / Long stroke
Protection	no protection, wiper (NBR), felt ring, bellow (TPE)
Volume compensation	Spring

## ▶ ADJUSTABLE ENERGY

### The adjustable

Can the High End series be surpassed? Yes, with the new adjustable series, the high energy absorption levels can be precisely adjusted to the entire stroke. Thus, the force is reduced and the damping is even softer.

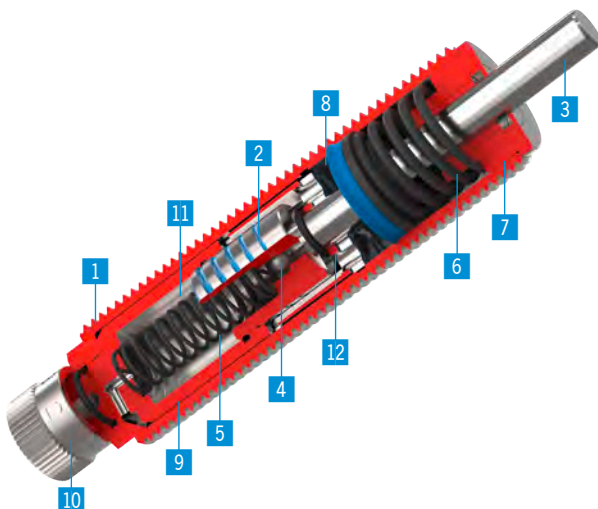

### PRODUCT ADVANTAGES

- ▶ Optimally adjustable damping across the entire stroke
- ▶ Reduced supporting force – decreased load on the design
- ▶ For the highest demands and maximum energy absorption
- ▶ Hardened and precision-ground guide

Series	▶ Technical data
Series	<b>Adjustable Energy</b>
Thread	M8 - M36
Pressure max. (abs.) [bar]	10
Stroke variant	Standard stroke / Long stroke
Protection	no protection, wiper (NBR), felt ring, bellow (TPE)
Volume compensation	Spring

7 Fixed stop/guide part

8 Oil reserve storage

9 Pressure sleeve

10 Adjusting screw

11 High-pressure chamber

12 Low-pressure chamber

# INDUSTRIAL SHOCK ABSORBERS POWERSTOP KNOW-HOW

## PowerStop®

The unique spiral groove technology is a defining feature of PowerStop brand industrial shock absorbers.

In contrast with conventional industrial shock absorbers with throttle bores, the constantly tapering spiral groove causes precise, low-vibration shock absorption. This means that PowerStop achieves maximum energy absorption with the smallest space.

### Our expertise – your advantages:

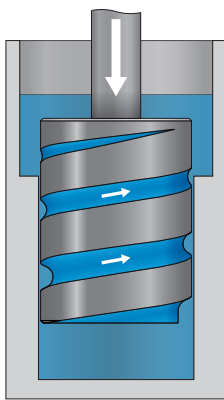

- ▶ Highest quality for the most extreme requirements and loads
- ▶ High energy absorption thanks to maximum utilization in each piston position
- ▶ Low-vibration and precise braking due to the constantly narrowing spiral groove
- ▶ Less wear thanks to the hydrostatic piston guide
- ▶ High level of operational safety and reliability
- ▶ Corrosion protection from using stainless steel
- ▶ Individual configuration for customized solutions

## Function

- ▶ An industrial shock absorber absorbs the energy of a moving mass and transforms the kinetic energy 100% into heat through the friction of the internal oil flow (**hydraulic damping**).

## Degree of hardness and adjustability – optimal damping adapted to velocity and utilization

- ▶ The degree of hardness of a hydraulic shock absorber represents the range of impact velocity for which the shock absorber is optimally designed for. The shock absorber reaches its maximum energy absorption per stroke within this velocity range.
- ▶ The throttle cross-section, and thus the flow of the oil from the high-pressure chamber to the low-pressure chamber, are primarily determined by the depth of the spiral groove and also by the annular surface between the piston and the running surface. This throttle behavior determines the force curve as a function of the velocity.
- ▶ Below the minimum speed, the shock absorber functions at a reduced energy absorption capacity due to the reduced throttle effect. There is a risk of bouncing when the impact velocity is exceeded. This means that the mass lifts slightly or recoils upon impact, because the oil at the throttle point cannot flow away quickly enough.
- ▶ The configurable Adjustable Energy series additionally features an integrated bypass, which has a throttle cross-section that softens the damper. Based on the degree of hardness H in the closed position at level 0, the bypass is opened to level 5 for a maximum velocity of up to 5 m/s.

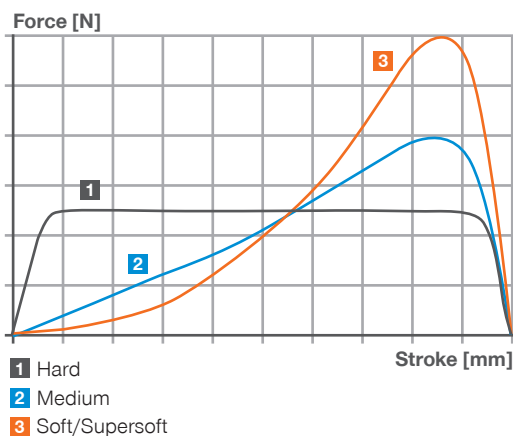

## Characteristics of the shock absorber curve

- ▶ As a default, the individual degrees of hardness tend to demonstrate the following characteristics in the force over stroke shock absorber curve.
- ▶ Due to the throttling, the characteristic depends upon the impact velocity and can thus only be indicated as a trend.

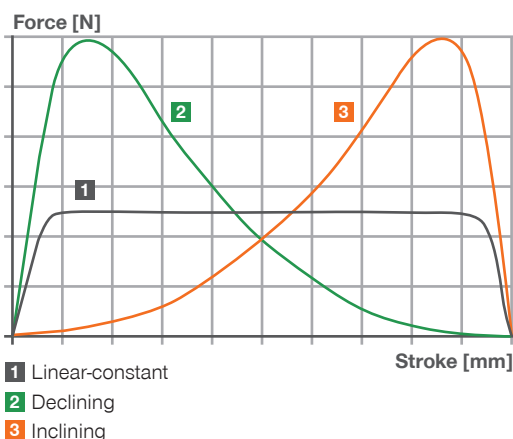

## Individual damping characteristics

- ▶ The spiral groove makes it possible for the shock absorber to demonstrate unique, customized characteristics. This means that the force curve can be configured progressively for a gentle increase in force, linear-constantly for a constant force curve with the lowest possible maximum force or on a diminishing scale for a weak end position force. By adjusting the spiral groove curve, the shock absorber can be optimally configured for your application when necessary.

# INDUSTRIAL SHOCK ABSORBERS POWERSTOP KNOW-HOW

## POWERSTOP INDUSTRIAL SHOCK ABSORBERS

### THROTTLE MECHANISM

**Spiral groove technology as a damping principle.**

In the case of the PowerStop industrial shock absorbers, the throttle effect necessary for damping is provided optimally and free of vibration by the circumferential, tapering spiral groove in the piston.

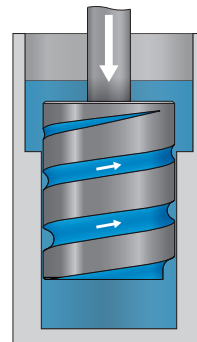

### Throttle characteristic

- ▶ The spiral groove tapers toward the top in the depth. With a retracting piston, the throttle cross-section affecting the trailing edge lessens.
- ▶ A constant decrease of the throttle surface results from the continuous progression of the spiral groove depth. This means that the shock absorber adapts ideally to the velocity reducing through the stroke and is optimally utilized for maximum energy absorption capacity in every piston position. In addition, the stress on the oil is reduced to a minimum.

Throttle surface

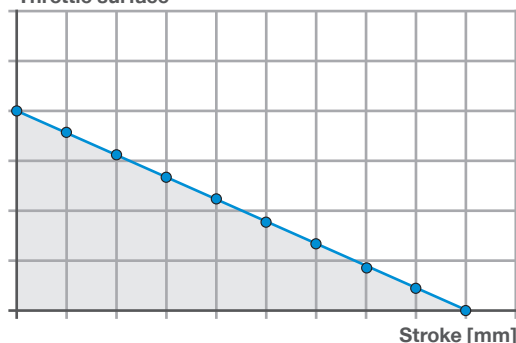

### Shock absorber curve

- ▶ The constant throttle characteristic results in a low-vibration, almost ideal force-stroke curve. The prevention of vibrations upon impact not only preserves the relevant components and systems, but also ensures jerk-free braking of the moving masses.

Force [N]

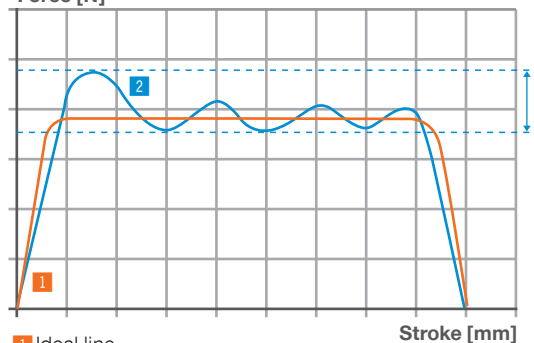

- 1 Ideal line
- 2 PowerStop

### Hydrostatic piston guide

- ▶ In addition to jerk-free damping, the spiral groove technology also provides reduced wear hydrostatic piston movement. Thanks to the spiral groove, oil is located between the piston and the running surface during the entire stroke. The relatively moving parts are separated by an anti-friction film, which minimizes wear. This guarantees a high degree of reliability.

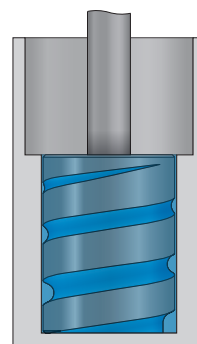

## CONVENTIONAL INDUSTRIAL SHOCK ABSORBERS

### THROTTLE MECHANISM

In the case of conventionally designed industrial shock absorbers, the throttle effect necessary for damping is provided in steps and burdened with vibrations by the throttle bores positioned in a sleeve.

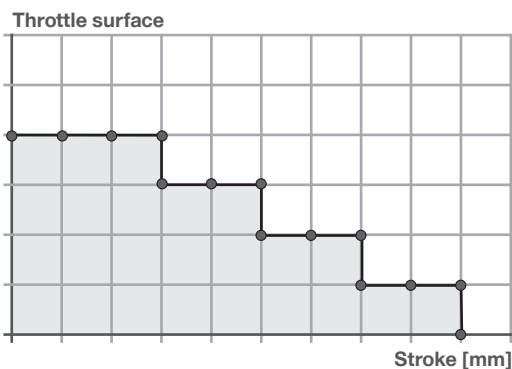
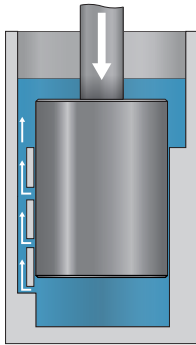

### Throttle characteristic

- ▶ The retracting piston gradually wears away the throttle bores laid out in the stroke direction, which reduces the throttle cross-section step by step.
- ▶ This results in an unsteady reduction of the throttle surface. This results in the shock absorber adapting only in certain areas to the velocity being reduced through the stroke. The oil is also greatly stressed by the forced detour.

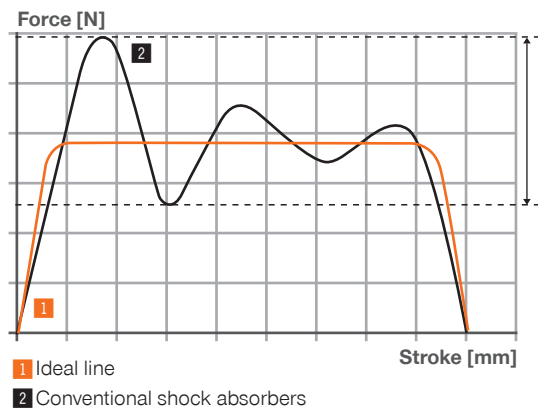

### Shock absorber curve

- ▶ The force-stroke characteristic curve is characterized by the inconsistent throttle characteristics that cause vibrations in the force curve. This in turn leads to vibrations and thus to damage to the machines, which is precisely what should be prevented by a shock absorber.

# INDUSTRIAL SHOCK ABSORBERS POWERSTOP

## FUNCTIONAL SEQUENCE

### ▶ 1. HOME POSITION

The ball check valve is opened and the oil volume reservoir is under light pre-load

When the Adjustable Energy series is used, the adjustment screw can be turned in order to open or close the bypass.

This can be done to adapt the energy absorption capacity or to adapt the impact velocity.

MINI ENERGY



STANDARD ENERGY



### ▶ 2. RETRACTION WITH DAMPING UP TO THE FIXED STOP

An external force or kinetic energy (impact) pushes the piston rod in together with the piston

- ▶ Pressure build-up in the high-pressure chamber
- ▶ The ball check valve closes
- ▶ The oil flows from the high-pressure chamber into the low-pressure chamber and the oil reserve storage via the spiral groove

- ▶ Due to the throttle effect of the spiral groove, a counterforce is generated via the stroke to the retracting piston to counteract the movement. When the Adjustable Energy series is used, this force can be reduced by opening the bypass
- ▶ Due to the friction of the throttled oil flow, the kinetic energy is converted into heat (hydraulic damping), whereby 100% of the kinetic energy is damped

MINI ENERGY



STANDARD ENERGY

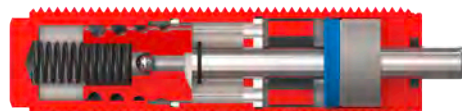

### ▶ 3. RETURNING

Removal of external force from the piston rod

- ▶ The return spring pushes the piston with the piston rod back into home position
- ▶ For a quick return, the ball check valve opens for a quick oil return flow

- ▶ The oil flows from the low-pressure chamber back into the high-pressure chamber through the ball check valve and the spiral groove

MINI ENERGY

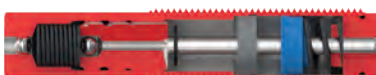

STANDARD ENERGY

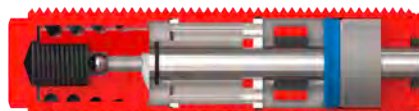



- ▶ The volume of the retracting piston rod is compensated by increasing the pre-load of the volume compensation
- ▶ When using the damping stroke, the piston rod is completely sunk into the damper and the moving mass rests on (and makes full-surface contact with) the top side of the damper, either directly or by means of the head. Here, the max. force in the end position must be observed

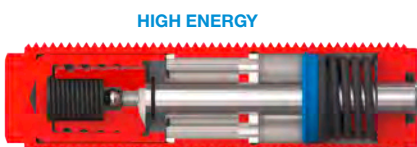
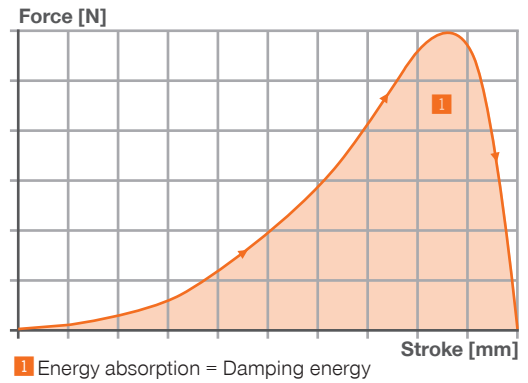

# INDUSTRIAL SHOCK ABSORBERS POWERSTOP

## MAXIMUM FLEXIBILITY

### A modular system that leaves nothing to be desired

The new assembly set makes it possible to combine highly versatile application-specific variants from four series, each with a stroke variant, speed range, protection and head. Everything comes from standard elements, delivering the shortest time to availability and ideal pricing. The new Mini Energy, Standard Energy, High Energy and Adjustable Energy series offer a number of refinements, significant improvements and enhancements.

## STROKE VARIANT

### Softer energy absorption

Thanks to the stepless taper, the invention of the spiral groove enabled the highest energy absorption levels in the smallest installation space and thus the smallest (N) strokes. However, not every machine is equipped for these kinds of loads, and not every design can handle such decelerations.

With the long stroke versions (L) the same respective energy absorption levels can be decelerated over a longer damping stroke, whereby the counterforce is reduced significantly for the softest possible damping.

**N** Normal stroke

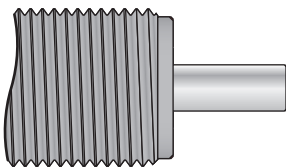

**L** Long stroke

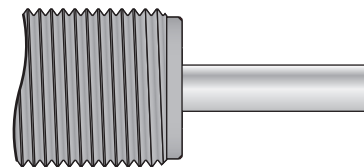

## DEGREE OF HARDNESS

### Degree of hardness and adjustability – optimal damping adapted to velocity

The flow of the organic oil from the high-pressure chamber to the low-pressure chamber is determined by the depth of the spiral groove, and the desired throttling is achieved. At low velocities, the flow through a flat spiral groove is low in order to achieve high throttling and high energy absorption. At high velocities, a deeper spiral groove ensures a sufficient flow to reduce the impact force and to prevent bouncing.

The Adjustable Energy series features an additional bypass that allows the flow to be adjusted with infinite variability. As a result, the damping can be optimally adapted to the speed.

**Closed position**

0% flow

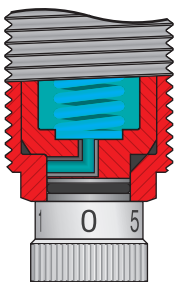

**Open position**

100% flow

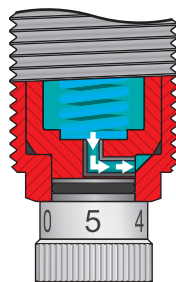



## PROTECTION

### Ideal protection in any environment

Thanks to the broad-ranging modular system, the PowerStop offers the right protection for any condition. In a clean environment, such as that of an assembly process, the damper does its job cost-effectively without any special protection (D). With the optional wiper (A) made of NBR, the damper is resistant to any kind of liquid or oil. The best way to keep dust and chips outside the damper, even when working with

wood, is with a felt ring (F). Finally, the bellow (B) made of TPE provides the highest level of protection against adverse conditions.

**D Without protection**  
in a clean environment

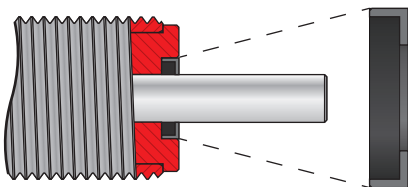

**A Wiper (NBR)**  
against liquid and oil

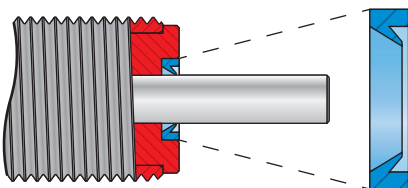

**F Felt ring**  
against dust and chips

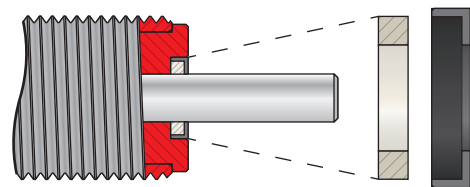

**B Bellow (TPE)**

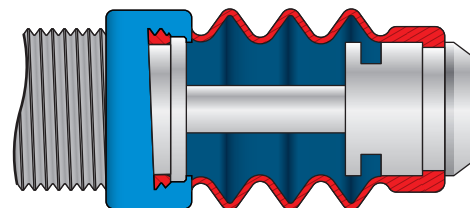

## HEADS

### Material-friendly and low-noise force absorption

The No head variant is available in the short piston rod version (D), where the piston rod protrudes from the housing by the maximum stroke of the respective damper, which means that this variant has an integrated fixed stop. The No head variant is also available with a long piston rod (E), where the piston rod protrudes further than the maximum stroke of the respective damper, which means that this variant does not have an integrated fixed stop.

The With head variant is available with a steel head (S) or with a plastic head (K). Thanks to the enlarged steel head area (S), the surface pressure upon impact is reduced, which is ideal for soft opposing materials. Using a plastic head (K) with an insert made of TPC material is recommended for reducing the amount of noise that is generated. These two With head variants are suitable for fixed stops. For even greater durability at inclined impact angles, all heads are rounded in order to absorb the load with reduced transverse force. For a secure hold, the heads are glued as well as

crimped via lateral grooves for reliable positioning with the piston rod.

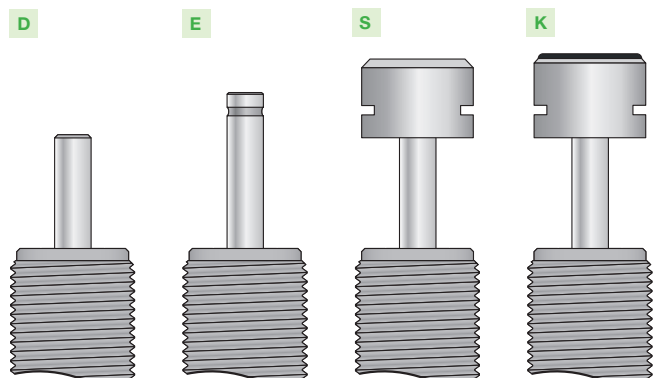

# POWERSTOP INDUSTRIAL SHOCK ABSORBER ACCESSORIES

## STOP SLEEVE | PAH

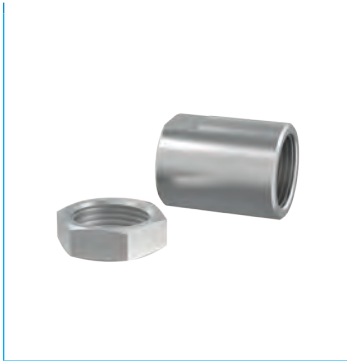

### Available for M4-M36

It is advisable to use a stop sleeve for optimal damping stroke adjustment. In this process, the end stop and the damping stroke can be adjusted individually by screwing the sleeve on the shock absorber external thread using the additional lock nut.

It is advisable to start by setting the ideal utilization of the damper by reducing the damping stroke. The end stop can subsequently be set using the position of the damper in the mounting piece.

The stop sleeve works either with or without a steel and plastic head, but not in conjunction with the bellow. The stop sleeve, including the additional lock nut contained in the scope of delivery, is made of stainless steel.

## SENSOR STOP SLEEVE | PSH



### Available for M8-M33 (with the exception of M16, M22 and M27)

In addition to the stop sleeve features, the sensor stop sleeve features inductive sensor with highly compact integration for sensing the end position of the set damping stroke. Using the sensor stop sleeve requires the use of an industrial shock absorber with a steel or plastic head (excluding the bellow).

Inductive sensor, PNP (NC), 2 m PUR cable, IP67 degree of protection.

See separate data sheet for additional information.

## SIDE LOAD ADAPTER | PBV



### Available for M8-M36 for normal and long stroke

If the industrial shock absorber is actuated with a higher angle of impact than the permissible misalignment of  $2^\circ$ , then a side load adapter must be provided. This increases the permissible angle of impact to  $30^\circ$ , which is especially advantageous for rotative applications. The side load adapter can only be used in combination with an industrial shock absorber without a head. Here, the damper can alternatively be screwed on using the external thread of the side load adapter.

Consisting of a piston rod and housing made of stainless steel, the side load adapter is available in two protection configurations.

#### **Protection: no protection**

in a clean environment

#### **Protection: Wiper**

Against liquids and oil

#### **Protection: Felt ring**

Against dust and chips

## CLAMPING FLANGE SCREWED ON ORTHOGONALLY | PKS



### Available for M8-M36

You can use a clamping flange made of nickel-plated steel to connect the shock absorber to the structure more easily. After being fully screwed in, the shock absorber is clamped tightly to the clamping flange by screwing at a right angle to the shock absorber and fastened to the structure, which makes the locknut unnecessary.

## CLAMPING FLANGE SCREWED PARALLEL | PKP



### Available for M8-M36

You can use a clamping flange made of nickel-plated steel to connect the shock absorber to the structure more easily. After being fully screwed in, the shock absorber is clamped tightly to the clamping flange by screwing in the screwing direction of the shock absorber and fastened to the structure, which makes the locknut unnecessary.

## LOCKNUT | PVM



### Available for M4-M36

A nut made of stainless steel is supplied for each industrial shock absorber. When installing in a drilled hole with no threading, an additional nut for attachment on both sides can be ordered at the same time.

## PRESSURE CHAMBER SEAL | PDD



### Available for M4-M36

If the industrial shock absorber is being used within a pressure chamber, for instance in a pneumatic cylinder or a swivel unit, then a pressure chamber seal is required for sealing the outer contour of the shock absorber. For ideal sealing, the seal must make full-surface contact on both sides. The seal itself is made of NBR, which is applied to corrosion-protected galvanised steel for stabilization purposes.

# INDUCTIVE PROXIMITY SWITCH



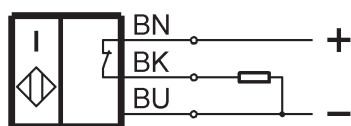
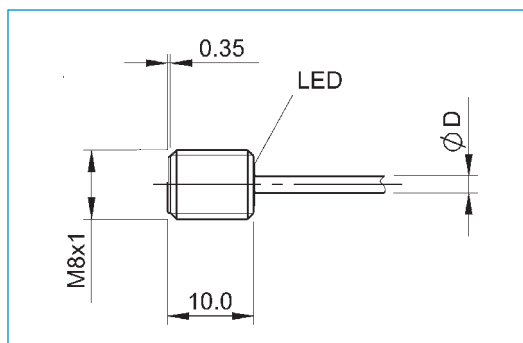

## SENSOR STOP SLEEVE | PSH

Accessories	
<b>General data</b>	
Certification	CE / UKCA / cULus / WEEE
Basic standard	IEC 60947-5-2
Protection to IEC 60529	IP67
Function display	Yes
Protected against polarity reversal	Yes
Power indicator	No
Short-circuit-proof	Yes
<b>Electrical data</b>	
Connection type	Cable
Effective operating voltage [V DC]	24
Rated insulation voltage [V DC]	75
Load current capacity [mA]	150
Rated short circuit current [A]	100
Supply voltage min. [V DC]	10
Supply voltage max. [V DC]	30
Electrical version	DC, direct current
Minimum operating current [mA]	1
Load capacitance max. [ $\mu$ F]	0.2
No-load current damped max. [mA]	3
Max. no-load current undamped [mA]	9
Ripple max. [%]	10
Switching output	PNP
Switching frequency [Hz]	3000
Switching function	Normally closed contact (NC)
Voltage drop [V]	2.5
<b>Mechanical data</b>	
Nr. of wires x diameter [mm <sup>2</sup> ]	3x0.073
Rated operating distance $S_n$ [mm]	2.00
Installation type	flush
Housing Material	Stainless steel
Assured switching distance $S_a$ [mm]	1.60
Cable- $\varnothing$ D [mm]	2.1
Cable length [m]	2
Effective operating distance $S_r$ [mm]	2
Depth [mm]	10
Ambient temperature range [°C]	-25 ... +70
Active surface material	PBT
Cable sheath material	PUR



# INDUSTRIAL SHOCK ABSORBERS POWERSTOP

## OVERVIEW OF PRODUCTS

	Design	Series	Thread	Stroke variant	Stroke max. [mm]	Impact velocity		Energy absorption max.			Without protection	Felt ring	Wiper (NBR)	Bellow (TPE)	Page
						min. [m/s]	max. [m/s]	Continuous operation		Emergency stop operation					
								per stroke [J]	per hour [J/h]	per stroke [J]					
	P	ME	04X05	N	4	0,1	2,2	0,8	2.100	0,8	D		A		30
	P	ME	05X05	N	4	0,1	2,2	0,8	2.100	0,8	D		A		34
	P	ME	06X05	N	5	0,1	3,5	1,8	5.000	1,8	D		A		38
	P	SE	08X10	N	6	0,1	5,0	1,5	10.000	1,5	D	F	A	B	42
	P	SE	10X10	N	8	0,1	5,0	3	22.000	3	D	F	A	B	46
	P	SE	12X10	N	10	0,1	5,0	9	33.000	9	D	F	A	B	50
	P	SE	14X10	N	12	0,1	5,0	20	50.000	20	D	F	A	B	54
	P	SE	14X15	N	12	0,1	5,0	20	50.000	20	D	F	A	B	58
	P	SE	16X10	N	12	0,1	5,0	20	50.000	20	D	F	A	B	62
	P	SE	16X15	N	12	0,1	5,0	20	50.000	20	D	F	A	B	66
	P	SE	20X15	N	15	0,1	5,0	41	90.000	41	D	F	A	B	70
	P	SE	22X15	N	15	0,1	5,0	41	90.000	41	D	F	A	B	74
	P	SE	25X15	N	25	0,1	5,0	105	120.000	105	D	F	A	B	78
	P	SE	27X15	N	25	0,1	5,0	105	120.000	105	D	F	A	B	82
	P	SE	27X30	N	25	0,1	5,0	105	120.000	105	D	F	A	B	86
	P	SE	33X15	N	30	0,1	5,0	185	140.000	185	D	F	A	B	90
	P	SE	36X15	N	30	0,1	5,0	185	140.000	185	D	F	A	B	94
	P	HE	08X10	N	6	0,1	5,0	3,5-4	10.000	4-5	D	F	A	B	42
	P	HE	10X10	N	8	0,1	5,0	9-10	22.000	11-13	D	F	A	B	46
	P	HE	12X10	N	10	0,1	5,0	16-18	33.000	21-25	D	F	A	B	50
	P	HE	14X10	N/L	12/20	0,1	5,0	28-34	50.000	30-42	D	F	A	B/-	54
	P	HE	14X15	N/L	12/20	0,1	5,0	28-34	50.000	30-42	D	F	A	B/-	58
	P	HE	16X10	N/L	12/20	0,1	5,0	28-34	50.000	30-42	D	F	A	B/-	62
	P	HE	16X15	N/L	12/20	0,1	5,0	28-34	50.000	30-42	D	F	A	B/-	66
	P	HE	20X15	N/L	15/25	0,1	5,0	65-80	90.000	75-150	D	F	A	B/-	70
	P	HE	22X15	N/L	15/25	0,1	5,0	65-80	90.000	75-150	D	F	A	B/-	74
	P	HE	25X15	N/L	25/40	0,1	5,0	160-220	120.000	190-400	D	F	A	B/-	78
	P	HE	27X15	N/L	25/40	0,1	5,0	160-220	120.000	190-400	D	F	A	B/-	82
	P	HE	27X30	N/L	25/40	0,1	5,0	160-220	120.000	190-400	D	F	A	B/-	86
	P	HE	33X15	N/L	30/50	0,1	5,0	280-400	140.000	350-800	D	F	A	B/-	90
	P	HE	36X15	N/L	30/50	0,1	5,0	280-400	140.000	350-800	D	F	A	B/-	94
	P	AE	08X10	N	6	0,1	5,0	4	10.000	4	D	F	A	B	42
	P	AE	10X10	N	8	0,1	5,0	10	22.000	13	D	F	A	B	46
	P	AE	12X10	N	10	0,1	5,0	18	33.000	18	D	F	A	B	50
	P	AE	14X10	N/L	12/20	0,1	5,0	34	50.000	34	D	F	A	B/-	54
	P	AE	14X15	N/L	12/20	0,1	5,0	34	50.000	34	D	F	A	B/-	58
	P	AE	16X10	N/L	12/20	0,1	5,0	34	50.000	34	D	F	A	B/-	62
	P	AE	16X15	N/L	12/20	0,1	5,0	34	50.000	34	D	F	A	B/-	66
	P	AE	20X15	N/L	15/25	0,1	5,0	80	90.000	80	D	F	A	B/-	70
	P	AE	22X15	N/L	15/25	0,1	5,0	80	90.000	80	D	F	A	B/-	74
	P	AE	25X15	N/L	25/40	0,1	5,0	220	120.000	220	D	F	A	B/-	78
	P	AE	27X15	N/L	25/40	0,1	5,0	220	120.000	220	D	F	A	B/-	82
	P	AE	27X30	N/L	25/40	0,1	5,0	220	120.000	220	D	F	A	B/-	86
	P	AE	33X15	N/L	30/50	0,1	5,0	400	140.000	400	D	F	A	B/-	90
	P	AE	36X15	N/L	30/50	0,1	5,0	400	140.000	400	D	F	A	B/-	94

# INDUSTRIAL SHOCK ABSORBERS POWERSTOP

## THREAD M4X0.5

### ► SERIES

PowerStop®

#### MINI ENERGY



The slender

► <b>Material</b>	Stainless steel	► <b>Organic oil (biodegradable)</b>	HEES
► <b>Permitted temperature range</b>	-10 ... +70 [°C]	- <b>H1-certified</b>	Yes
► <b>Angle of Impact max.</b>	2 [°]	- <b>PWIS-free</b>	Yes
► <b>Max. force at fixed stop</b>	0.2 [kN]	► <b>RoHS compliant</b> - <b>REACH compliant</b>	Yes
► <b>Lock nut tightening torque</b>		► <b>Max. absolute pressure</b>	
- <b>Mini Energy</b>	1 [Nm]	- <b>Mini Energy</b>	10 [bar]

### ► TECHNICAL DATA

Design	Series	Thread	Stroke variant	Stroke max. [mm]	Hardness degree	Impact velocity			Energy absorption max.			Protection	Reset			Head	Integrated Fix stop	Version
						min.	max.	per stroke	per hour	per stroke	min.		max.	max.				
															[m/s]			
MINI ENERGY	P	ME	04X05	N	4	H	0,1	1,2	0,8	2.100	0,8	D	1	2	0,15	D	x	-B
					-							-				E	-	
					M	0,8	2,2	0,8	2.100	0,8	A	1	2	0,15	S	x		
																K	x	

## ► PROTECTION

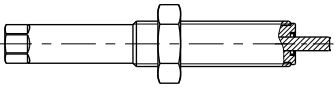
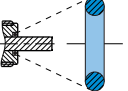
no protection	Wiper (NBR)
D -B	A -B
	
in a clean environment	against liquid, oil, ...

## ► TECHNICAL DRAWINGS

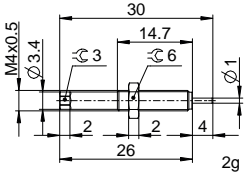
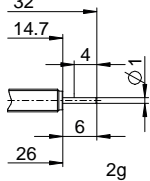
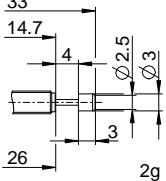
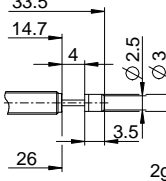
	Short piston rod no head	Long piston rod no head	with steel head	with plastic head
	N D -B	N E -B	N S -B	N K -B
<b>MINI ENERGY</b>				

# INDUSTRIAL SHOCK ABSORBERS POWERSTOP

## THREAD M4X0.5

### ▶ ACCESSORIES

Pos.	Order no.	Accessories	Remarks
①	<b>PAH04X05-A</b>	Stop sleeve	Including 1x PVM04X05-A. Industrial shock absorber with bellow excluded.
②	<b>PVM04X05-A</b>	Stainless steel locknut	Included with the industrial shock absorber.
③	<b>PDD04X05-A</b>	Pressure chamber seal	Recommended fixation with PVM04X05-A. Seal must be in full contact on both sides.

①

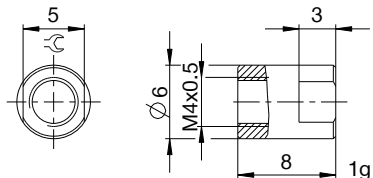

②

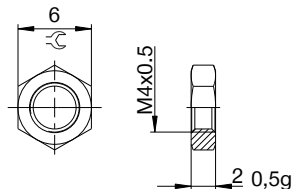

③

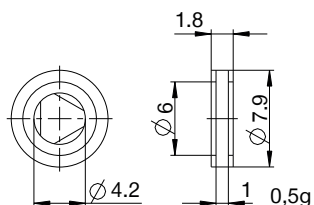



## ▶ CLASSIFICATION

P ME 04X05 N M D S -B

### Design

**P** Industrial shock absorbers PowerStop

### Series

**ME** Mini Energy

**SE** Standard Energy

**HE** High Energy

**AE** Adjustable Energy

### Thread

**04** Thread nominal diameter

**X**

**05** Thread pitch (factor 10)

### Stroke variant

**N** Standard stroke

**L** Long stroke

### Hardness degree

**H** Hard (0.1 - 1.2 m/s; Adjustable Energy: 0.1 - 5 m/s)

**M** Medium (0.8 - 2.2 m/s)

**S** Soft (1.8 - 3.5 m/s)

**W** Supersoft (3 - 5 m/s)

### Protection

**D** no protection

**F** Felt ring

**A** Wiper (NBR)

**B** Bellow (TPE)

### Head

**D** Short piston rod no head

**E** Long piston rod no head

**S** with steel head

**K** with plastic head

### Version

**-A** Versioning from a to z

# INDUSTRIAL SHOCK ABSORBERS POWERSTOP

## THREAD M5X0.5

### ► SERIES



#### MINI ENERGY



The slender

► <b>Material</b>	Stainless steel	► <b>Organic oil (biodegradable)</b>	HEES
► <b>Permitted temperature range</b>	-10 ... +70 [°C]	- <b>H1-certified</b>	Yes
► <b>Angle of Impact max.</b>	2 [°]	- <b>PWIS-free</b>	Yes
► <b>Max. force at fixed stop</b>	0.2 [kN]	► <b>RoHS compliant</b> - <b>REACH compliant</b>	Yes
► <b>Lock nut tightening torque</b>		► <b>Max. absolute pressure</b>	
- <b>Mini Energy</b>	1 [Nm]	- <b>Mini Energy</b>	10 [bar]

### ► TECHNICAL DATA

Design	Series	Thread	Stroke variant	Stroke max. [mm]	Hardness degree	Impact velocity		Energy absorption max.			Protection	Reset			Head	Integrated Fix stop	Version	
						min.	max.	Continuous operation		Emergency stop operation		Force		Time				
								per stroke	per hour			per stroke	min.					max.
[m/s]	[m/s]	[J]	[J/h]	[J]	[N]	[N]	[s]											
MINI ENERGY	P	ME	05X05	N	4	H	0,1	1,2	0,8	2.100	0,8	D	1	2	0,15	D	x	-B
						-												
						M	0,8	2,2	0,8	2.100	0,8	A	1	2	0,15	E	-	
																S	x	
																K	x	

## PROTECTION

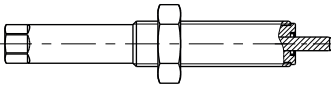
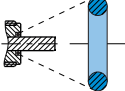
no protection	Wiper (NBR)
D -B	A -B
	
in a clean environment	against liquid, oil, ...

## TECHNICAL DRAWINGS

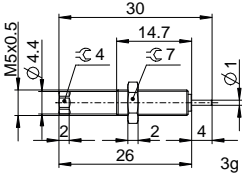
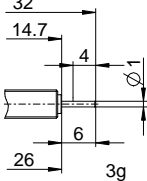
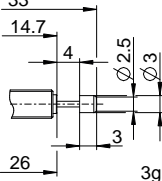
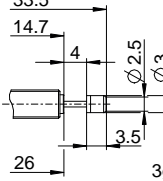
	Short piston rod no head	Long piston rod no head	with steel head	with plastic head
	N D -B	N E -B	N S -B	N K -B
<b>MINI ENERGY</b>				

# INDUSTRIAL SHOCK ABSORBERS POWERSTOP

## THREAD M5X0.5

### ACCESSORIES

Pos.	Order no.	Accessories	Remarks
①	<b>PAH05X05-A</b>	Stop sleeve	Including 1x PVM05X05-A. Industrial shock absorber with bellow excluded.
②	<b>PVM05X05-A</b>	Stainless steel locknut	Included with the industrial shock absorber.
③	<b>PDD05X05-A</b>	Pressure chamber seal	Recommended fixation with PVM05X05-A. Seal must be in full contact on both sides.

①

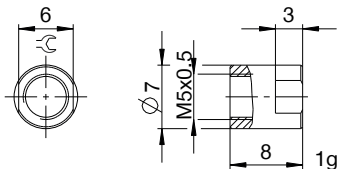

②

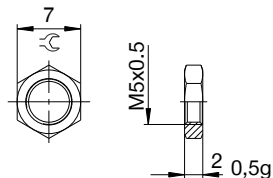

③

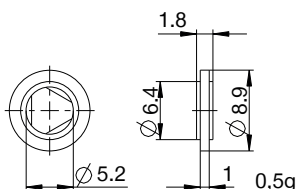

## ▶ CLASSIFICATION

**P** **ME** **05X05** **N** **H** **A** **D** **-B**

### Design

**P** Industrial shock absorbers PowerStop

### Series

**ME** Mini Energy

**SE** Standard Energy

**HE** High Energy

**AE** Adjustable Energy

### Thread

**05** Thread nominal diameter

**X**

**05** Thread pitch (factor 10)

### Stroke variant

**N** Standard stroke

**L** Long stroke

### Hardness degree

**H** Hard (0.1 - 1.2 m/s; Adjustable Energy: 0.1 - 5 m/s)

**M** Medium (0.8 - 2.2 m/s)

**S** Soft (1.8 - 3.5 m/s)

**W** Supersoft (3 - 5 m/s)

### Protection

**D** no protection

**F** Felt ring

**A** Wiper (NBR)

**B** Bellow (TPE)

### Head

**D** Short piston rod no head

**E** Long piston rod no head

**S** with steel head

**K** with plastic head

### Version

**-A** Versioning from a to z

# INDUSTRIAL SHOCK ABSORBERS POWERSTOP

## THREAD M6X0.5

### ► SERIES



#### MINI ENERGY



The slender

- **Material** Stainless steel ► **Organic oil (biodegradable)** HEES
- **Permitted temperature range** -10 ... +70 [°C] - **H1-certified** Yes
- **Angle of Impact max.** 2 [°] - **PWIS-free** Yes
- **Max. force at fixed stop** 0.5 [kN] ► **RoHS compliant** - **REACH compliant** Yes
- **Lock nut tightening torque**
  - **Mini Energy** 2 [Nm] - **Mini Energy** 10 [bar]

### ► TECHNICAL DATA

Design	Series	Thread	Stroke variant	Stroke max. [mm]	Hardness degree	Impact velocity		Energy absorption max.			Protection	Reset			Head	Integrated Fix stop	Version				
						min. [m/s]	max. [m/s]	Continuous operation		Emergency stop operation per stroke [J]		min. [N]	max. [N]	Time max. [s]							
								per stroke [J]	per hour [J/h]									per stroke [J]			
MINI ENERGY	P	ME	06X05	N	5	H	0,1	1,2	1,8	5.000	1,8	D	1,5	2,5	0,15	x	-A				
						-															
						M	0,8	2,2	1,8	5.000	1,8										
					S	1,8	3,5	1,8	5.000	1,8	A	1,5	2,5	0,15	x						

## PROTECTION

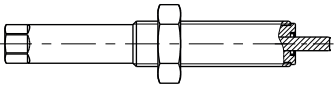
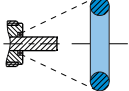
no protection	Wiper (NBR)
D -A	A -A
	
in a clean environment	against liquid, oil, ...

## TECHNICAL DRAWINGS

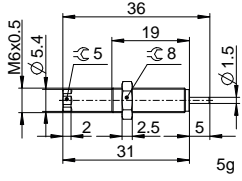
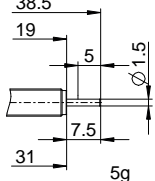
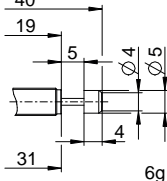
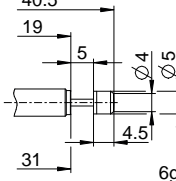
	Short piston rod no head	Long piston rod no head	with steel head	with plastic head
	N D -A	N E -A	N S -A	N K -A
<b>MINI ENERGY</b>				

# INDUSTRIAL SHOCK ABSORBERS POWERSTOP

## THREAD M6X0.5

### ACCESSORIES

Pos.	Order no.	Accessories	Remarks
①	<b>PAH06X05-A</b>	Stop sleeve	Including 1x PVM06X05-A. Industrial shock absorber with bellow excluded.
②	<b>PVM06X05-A</b>	Stainless steel locknut	Included with the industrial shock absorber.
③	<b>PDD06X05-A</b>	Pressure chamber seal	Recommended fixation with PVM06X05-A. Seal must be in full contact on both sides.

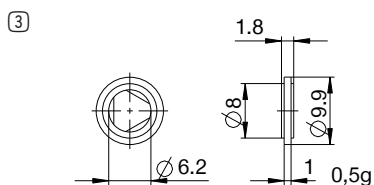
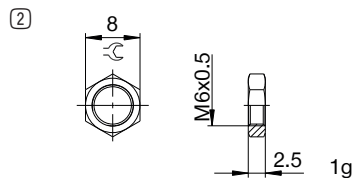
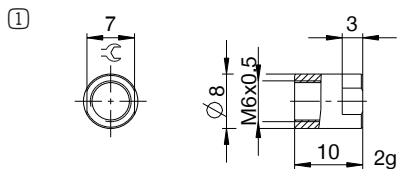



## ▶ CLASSIFICATION

P ME 06X05 N S D S -A

### Design

**P** Industrial shock absorbers PowerStop

### Series

**ME** Mini Energy

**SE** Standard Energy

**HE** High Energy

**AE** Adjustable Energy

### Thread

**06** Thread nominal diameter

**X**

**05** Thread pitch (factor 10)

### Stroke variant

**N** Standard stroke

**L** Long stroke

### Hardness degree

**H** Hard (0.1 - 1.2 m/s; Adjustable Energy: 0.1 - 5 m/s)

**M** Medium (0.8 - 2.2 m/s)

**S** Soft (1.8 - 3.5 m/s)

**W** Supersoft (3 - 5 m/s)

### Protection

**D** no protection

**F** Felt ring

**A** Wiper (NBR)

**B** Bellow (TPE)

### Head

**D** Short piston rod no head

**E** Long piston rod no head

**S** with steel head

**K** with plastic head

### Version

**-A** Versioning from a to z

# INDUSTRIAL SHOCK ABSORBERS POWERSTOP THREAD M8X1

## ► SERIES

PowerStop®



► <b>Material</b>	Stainless steel	► <b>Organic oil (biodegradable)</b>	HEES
► <b>Permitted temperature range</b>	-10 ... +70 [°C]	- <b>H1-certified</b>	Yes
► <b>Angle of Impact max.</b>	2 [°]	- <b>PWIS-free</b>	Yes
► <b>Max. force at fixed stop</b>	1 [kN]	► <b>RoHS compliant</b> - <b>REACH compliant</b>	Yes
► <b>Lock nut tightening torque</b>		► <b>Max. absolute pressure</b>	
- <b>Standard energy</b>	3 [Nm]	- <b>Standard energy</b>	1 [bar]
- <b>High Energy</b>	3 [Nm]	- <b>High Energy</b>	10 [bar]
- <b>Adjustable Energy</b>	3 [Nm]	- <b>Adjustable Energy</b>	10 [bar]

## ► TECHNICAL DATA

	Design	Series	Thread	Stroke variant	Stroke max. [mm]	Hardness degree	Impact velocity			Energy absorption max.			Protection	Reset			Head Integrated Fix stop	Version
							min.	max.	per stroke	per hour	per stroke	Force min. [N]		Force max. [N]	Time max. [s]			
																[m/s]		
STANDARD ENERGY	P	SE	08X10	N	6	H	0,1	1,2	1,5	10.000	1,5	D	1,5	3,0	0,2	D	x	-A
						M	0,8	2,2	1,5	10.000	1,5	F	1,5	3,0	0,2	E	-	
						S	1,8	3,5	1,5	10.000	1,5	A	1,5	3,0	0,2	S	x	
						W	3,0	5,0	1,5	10.000	1,5	B	1,5	4,5	0,2	K	x	
HIGH ENERGY	P	HE	08X10	N	6	H	0,1	1,2	4	10.000	5	D	2,5	4,5	0,2	D	x	-A
						M	0,8	2,2	4	10.000	5	F	2,5	4,5	0,2	E	-	
						S	1,8	3,5	3,5	10.000	4	A	2,5	4,5	0,2	S	x	
						W	3,0	5,0	3,5	10.000	4	B	2,5	6,0	0,2	K	x	
ADJUSTABLE ENERGY	P	AE	08X10	N	6	H	0,1	5,0	4	10.000	4	D	2,5	4,5	0,2	D	x	-A
						M						F	2,5	4,5	0,2	E	-	
						S						A	2,5	4,5	0,2	S	x	
						W						B	2,5	6,0	0,2	K	x	

## PROTECTION

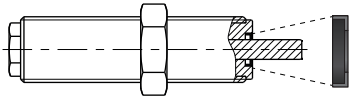
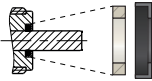
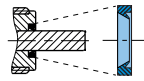
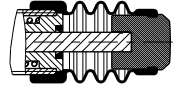
D -A	F -A	A -A	B -A
			
in a clean environment	against dust, chips, ...	against liquid, oil, ...	

## TECHNICAL DRAWINGS

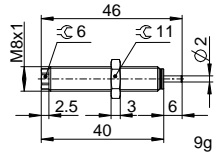
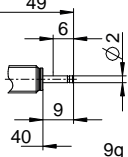
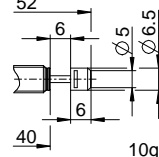
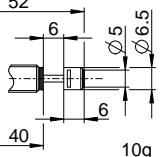
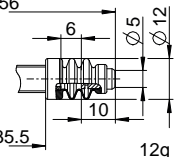
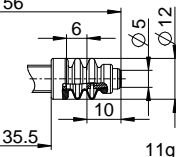
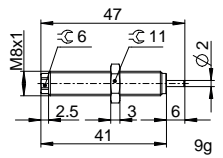
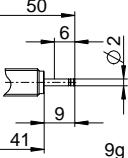
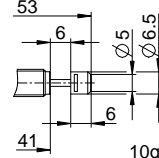
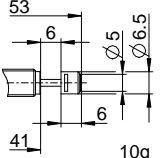
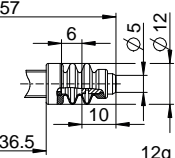
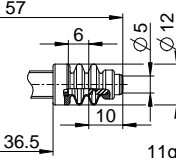
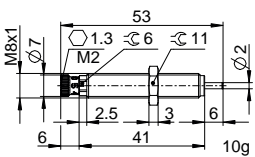
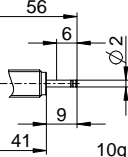
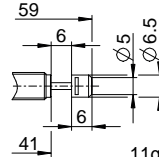
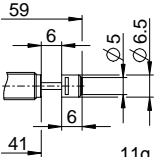
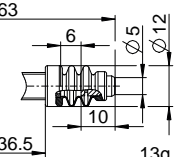
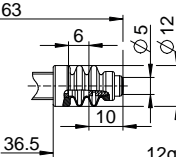
	Short piston rod no head	Long piston rod no head	with steel head	with plastic head	with bellow and steel head	with bellow and plastic head
	N D -A	N E -A	N S -A	N K -A	N B S -A	N B K -A
STANDARD ENERGY						
HIGH ENERGY						
ADJUSTABLE ENERGY						

# INDUSTRIAL SHOCK ABSORBERS POWERSTOP

## THREAD M8X1

### ▶ ACCESSORIES

Pos.	Order no.	Accessories	Remarks
①	<b>PAH08X10-A</b>	Stop sleeve	Including 1x PVM08X10-A. Industrial shock absorber with bellow excluded.
②	<b>PSH08X10-B</b>	Sensor stop sleeve	Including 1x PVM08X10-A. Sensing only possible via industrial shock absorbers with steel or plastic head. Industrial shock absorber with bellow excluded. Inductive sensor, PNP (NC), 2 m PUR cable, IP67 degree of protection. See separate data sheet for additional information.
③	<b>PBV08X10ND-A</b>	Side load adapter standard stroke Protection: no protection	Impact angle max. 30°. Can only be used in combination with industrial shock absorber without protection and without the Short piston rod no head variant. Lock nut PVM12X10-A suitable for external thread of the side load adapter.
④	<b>PBV08X10NF-A</b>	Side load adapter standard stroke Protection: felt ring (felt)	Impact angle max. 30°. Can only be used in combination with industrial shock absorber without protection and without the Short piston rod no head variant. Lock nut PVM12X10-A suitable for external thread of the side load adapter.
⑤	<b>PBV08X10NA-A</b>	Side load adapter standard stroke Protection: wiper (NBR)	Impact angle max. 30°. Can only be used in combination with industrial shock absorber without protection and without the Short piston rod no head variant. Lock nut PVM12X10-A suitable for external thread of the side load adapter.
⑥	<b>PKS08X10-A</b>	Clamping flange orthogonal screwed	Tightening torque of the screws max. 3 Nm.
⑦	<b>PKP08X10-A</b>	Clamping flange screwed in parallel	Tightening torque of the screws max. 1 Nm.
⑧	<b>PVM08X10-A</b>	Stainless steel locknut	Included with the industrial shock absorber.
⑨	<b>PDD08X10-A</b>	Pressure chamber seal	Recommended fixation with PVM08X10-A. Seal must be in full contact on both sides.

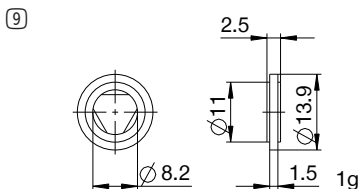
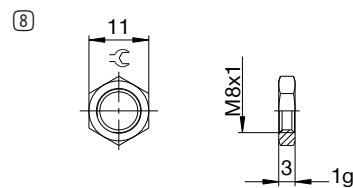
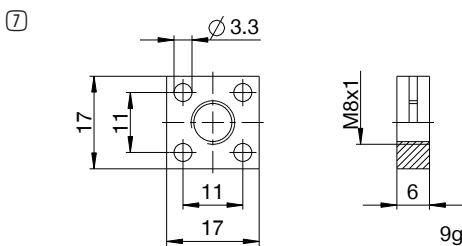
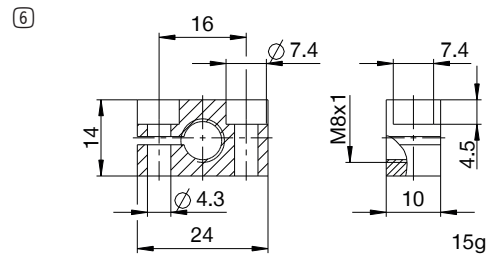
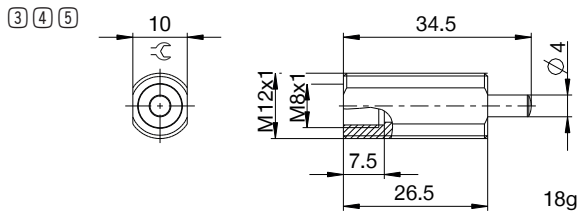
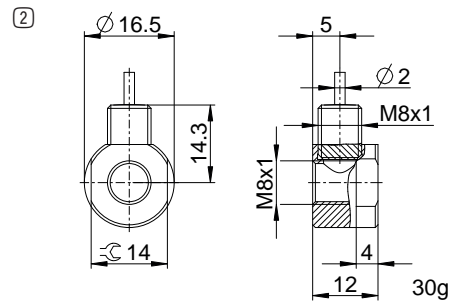
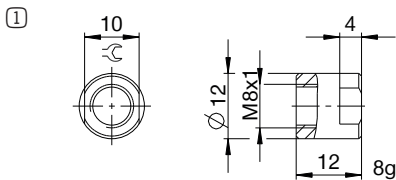

## ▶ CLASSIFICATION

**P SE 08X10 N W A K -A**

### Design

**P** Industrial shock absorbers PowerStop

### Series

**ME** Mini Energy

**SE** Standard Energy

**HE** High Energy

**AE** Adjustable Energy

### Thread

**08** Thread nominal diameter

**X**

**10** Thread pitch (factor 10)

### Stroke variant

**N** Standard stroke

**L** Long stroke

### Hardness degree

**H** Hard (0.1 - 1.2 m/s; Adjustable Energy: 0.1 - 5 m/s)

**M** Medium (0.8 - 2.2 m/s)

**S** Soft (1.8 - 3.5 m/s)

**W** Supersoft (3 - 5 m/s)

### Protection

**D** no protection

**F** Felt ring

**A** Wiper (NBR)

**B** Bellow (TPE)

### Head

**D** Short piston rod no head

**E** Long piston rod no head

**S** with steel head

**K** with plastic head

### Version

**-A** Versioning from a to z

# INDUSTRIAL SHOCK ABSORBERS POWERSTOP THREAD M10X1

## ► SERIES

PowerStop®



► <b>Material</b>	Stainless steel	► <b>Organic oil (biodegradable)</b>	HEES
► <b>Permitted temperature range</b>	-10 ... +70 [°C]	- <b>H1-certified</b>	Yes
► <b>Angle of Impact max.</b>	2 [°]	- <b>PWIS-free</b>	Yes
► <b>Max. force at fixed stop</b>	2 [kN]	► <b>RoHS compliant</b> - <b>REACH compliant</b>	Yes
► <b>Lock nut tightening torque</b>		► <b>Max. absolute pressure</b>	
- <b>Standard energy</b>	4 [Nm]	- <b>Standard energy</b>	1 [bar]
- <b>High Energy</b>	4 [Nm]	- <b>High Energy</b>	10 [bar]
- <b>Adjustable Energy</b>	4 [Nm]	- <b>Adjustable Energy</b>	10 [bar]

## ► TECHNICAL DATA

	Design	Series	Thread	Stroke variant	Stroke max. [mm]	Hardness degree	Impact velocity		Energy absorption max.			Protection	Reset			Head Integrated Fix stop	Version	
							min.	max.	Continuous operation		Emergency stop operation		Force min. [N]	Time max. [s]				
									per stroke [J]	per hour [J/h]					per stroke [J]			
STANDARD ENERGY	P	SE	10X10	N	8	H	0,1	1,2	3	22.000	3	D	2	4	0,2	D	x	
							M	0,8	2,2	3	22.000	3	F	2	4	0,2	E	-
							S	1,8	3,5	3	22.000	3	A	2	4	0,2	S	x
							W	3,0	5,0	3	22.000	3	B	2	9	0,2	K	x
HIGH ENERGY	P	HE	10X10	N	8	H	0,1	1,2	10	22.000	13	D	3,5	6	0,2	D	x	
							M	0,8	2,2	10	22.000	13	F	3,5	6	0,2	E	-
							S	1,8	3,5	9	22.000	11	A	3,5	6	0,2	S	x
							W	3,0	5,0	9	22.000	11	B	3,5	11	0,2	K	x
ADJUSTABLE ENERGY	P	AE	10X10	N	8	H	0,1	5,0	10	22.000	10	D	3,5	6	0,2	D	x	
							M	0,8	2,2	10	22.000	13	F	3,5	6	0,2	E	-
							S	1,8	3,5	9	22.000	11	A	3,5	6	0,2	S	x
							W	3,0	5,0	9	22.000	11	B	3,5	11	0,2	K	x

## PROTECTION

no protection	Felt ring	Wiper (NBR)	Bellow (TPE)
D -A	F -A	A -A	B -A
in a clean environment	against dust, chips, ...	against liquid, oil, ...	

## TECHNICAL DRAWINGS

	Short piston rod no head	Long piston rod no head	with steel head	with plastic head	with bellow and steel head	with bellow and plastic head
	N D -A	N E -A	N S -A	N K -A	N B S -A	N B K -A
STANDARD ENERGY	 54.5, M10x1, 7, 13, 2.5, 2.5, 4, 8, 46.5, 19g	 58, 8, 2.5, 46.5, 11.5, 19g	 61, 8, 6, 8.5, 6.5, 46.5, 21g	 61, 8, 6, 8.5, 6.5, 46.5, 21g	 65, 8, 6, 14, 10.5, 41, 23g	 65, 8, 6, 14, 10.5, 41, 23g
HIGH ENERGY	 56, M10x1, 7, 13, 2.5, 2.5, 4, 8, 48, 20g	 59.5, 8, 2.5, 48, 11.5, 20g	 62.5, 8, 6, 8.5, 6.5, 48, 22g	 62.5, 8, 6, 8.5, 6.5, 48, 22g	 66.5, 8, 6, 14, 10.5, 42.5, 24g	 66.5, 8, 6, 14, 10.5, 42.5, 24g
ADJUSTABLE ENERGY	 62.5, M10x1, 7, 1.3, 7, 13, 2.5, 2.5, 4, 8, 6.5, 48, 21g	 66, 8, 2.5, 48, 11.5, 21g	 69, 8, 6, 8.5, 6.5, 48, 23g	 69, 8, 6, 8.5, 6.5, 48, 23g	 73, 8, 6, 14, 10.5, 42.5, 25g	 73, 8, 6, 14, 10.5, 42.5, 25g



# INDUSTRIAL SHOCK ABSORBERS POWERSTOP

## THREAD M10X1

### ▶ ACCESSORIES

Pos.	Order no.	Accessories	Remarks
①	<b>PAH10X10-A</b>	Stop sleeve	Including 1x PVM10X10-A. Industrial shock absorber with bellow excluded.
②	<b>PSH10X10-B</b>	Sensor stop sleeve	Including 1x PVM10x10-A. Sensing only possible via industrial shock absorbers with steel or plastic head. Industrial shock absorber with bellow excluded. Inductive sensor, PNP (NC), 2 m PUR cable, IP67 degree of protection. See separate data sheet for additional information.
③	<b>PBV10X10ND-A</b>	Side load adapter standard stroke Protection: no protection	Impact angle max. 30°. Can only be used in combination with industrial shock absorber without protection and without the Short piston rod no head variant. Lock nut PVM14X10-A suitable for external thread of the side load adapter.
④	<b>PBV10X10NF-A</b>	Side load adapter standard stroke Protection: felt ring (felt)	Impact angle max. 30°. Can only be used in combination with industrial shock absorber without protection and without the Short piston rod no head variant. Lock nut PVM14X10-A suitable for external thread of the side load adapter.
⑤	<b>PBV10X10NA-A</b>	Side load adapter standard stroke Protection: wiper (NBR)	Impact angle max. 30°. Can only be used in combination with industrial shock absorber without protection and without the Short piston rod no head variant. Lock nut PVM14X10-A suitable for external thread of the side load adapter.
⑥	<b>PKS10X10-A</b>	Clamping flange orthogonal screwed	Tightening torque of the screws max. 3 Nm.
⑦	<b>PKP10X10-A</b>	Clamping flange screwed in parallel	Tightening torque of the screws max. 1 Nm.
⑧	<b>PVM10X10-A</b>	Stainless steel locknut	Included with the industrial shock absorber.
⑨	<b>PDD10X10-A</b>	Pressure chamber seal	Recommended fixation with PVM10X10-A. Seal must be in full contact on both sides.

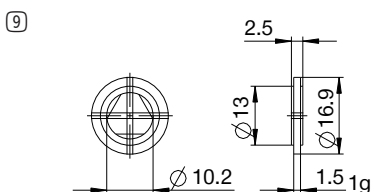
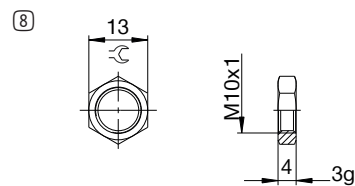
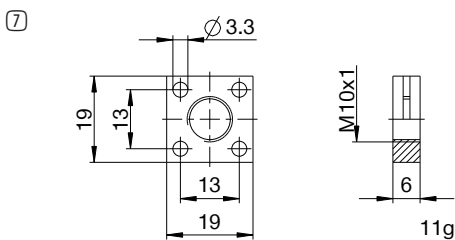
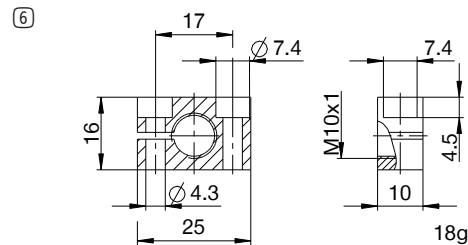
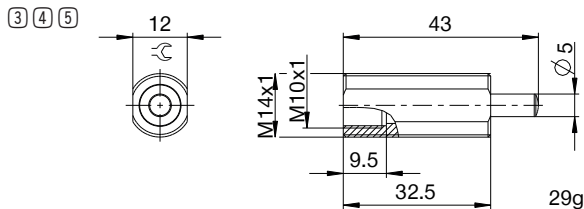
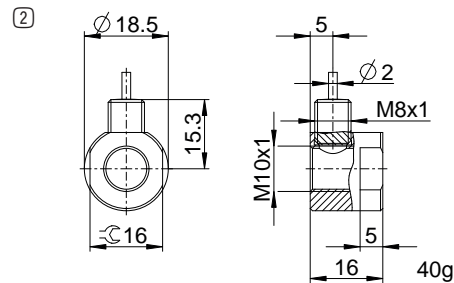
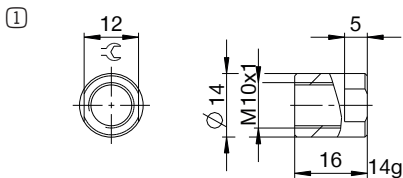



## ▶ CLASSIFICATION

**P** **HE** **10X10** **N** **H** **B** **S** **-A**

### Design

**P** Industrial shock absorbers PowerStop

### Series

**ME** Mini Energy

**SE** Standard Energy

**HE** High Energy

**AE** Adjustable Energy

### Thread

**10** Thread nominal diameter

**X**

**10** Thread pitch (factor 10)

### Stroke variant

**N** Standard stroke

**L** Long stroke

### Hardness degree

**H** Hard (0.1 - 1.2 m/s; Adjustable Energy: 0.1 - 5 m/s)

**M** Medium (0.8 - 2.2 m/s)

**S** Soft (1.8 - 3.5 m/s)

**W** Supersoft (3 - 5 m/s)

### Protection

**D** no protection

**F** Felt ring

**A** Wiper (NBR)

**B** Bellow (TPE)

### Head

**D** Short piston rod no head

**E** Long piston rod no head

**S** with steel head

**K** with plastic head

### Version

**-A** Versioning from a to z

# INDUSTRIAL SHOCK ABSORBERS POWERSTOP THREAD M12X1

## ► SERIES

PowerStop®



► <b>Material</b>	Stainless steel	► <b>Organic oil (biodegradable)</b>	HEES
► <b>Permitted temperature range</b>	-10 ... +70 [°C]	- <b>H1-certified</b>	Yes
► <b>Angle of Impact max.</b>	2 [°]	- <b>PWIS-free</b>	Yes
► <b>Max. force at fixed stop</b>	3 [kN]	► <b>RoHS compliant</b> - <b>REACH compliant</b>	Yes
► <b>Lock nut tightening torque</b>		► <b>Max. absolute pressure</b>	
- <b>Standard energy</b>	7 [Nm]	- <b>Standard energy</b>	1 [bar]
- <b>High Energy</b>	7 [Nm]	- <b>High Energy</b>	10 [bar]
- <b>Adjustable Energy</b>	7 [Nm]	- <b>Adjustable Energy</b>	10 [bar]

## ► TECHNICAL DATA

	Design	Series	Thread	Stroke variant	Stroke max. [mm]	Hardness degree	Impact velocity		Energy absorption max.			Protection	Reset			Head Integrated Fix stop	Version		
							min.	max.	Continuous operation		Emergency stop operation		Force		Time				
									per stroke	per hour			per stroke	min.				max.	max.
					[m/s]	[m/s]	[J]	[J/h]	[J]	[N]	[N]	[s]							
STANDARD ENERGY	P	SE	12X10	N	10	H	0,1	1,2	9	33.000	9	D	2,5	5	0,2	D	x		
							M	0,8	2,2	9	33.000	9	F	2,5	5	0,2	E	-	
								S	1,8	3,5	9	33.000	9	A	2,5	5	0,2	S	x
									W	3,0	5,0	9	33.000	9	B	2,5	17	0,2	K
HIGH ENERGY	P	HE	12X10	N	10	H	0,1	1,2	18	33.000	25	D	4,5	7,5	0,2	D	x		
							M	0,8	2,2	18	33.000	25	F	4,5	7,5	0,2	E	-	
								S	1,8	3,5	16	33.000	21	A	4,5	7,5	0,2	S	x
									W	3,0	5,0	16	33.000	21	B	4,5	19	0,2	K
ADJUSTABLE ENERGY	P	AE	12X10	N	10	H	0,1	5,0	18	33.000	18	D	4,5	7,5	0,2	D	x		
							M	0,8	5,0	18	33.000	18	F	4,5	7,5	0,2	E	-	
								S	1,8	5,0	18	33.000	18	A	4,5	7,5	0,2	S	x
									W	3,0	5,0	18	33.000	18	B	4,5	19	0,2	K

## PROTECTION

no protection D -A	Felt ring F -A	Wiper (NBR) A -A	Bellow (TPE) B -A
in a clean environment	against dust, chips, ...	against liquid, oil, ...	

## TECHNICAL DRAWINGS

	Short piston rod no head N D -A	Long piston rod no head N E -A	with steel head N S -A	with plastic head N K -A	with bellow and steel head N B S -A	with bellow and plastic head N B K -A
STANDARD ENERGY	 64, 8, 15, 2.5, 5, 10, 3, 54, 30g	 68, 10, 3, 14, 54, 30g	 71, 10, 7, 10.5, 7, 54, 34g	 71, 10, 7, 10.5, 7, 54, 33g	 75, 10, 7, 16, 11, 47.5, 37g	 75, 10, 7, 16, 11, 47.5, 36g
HIGH ENERGY	 66, 8, 15, 2.5, 5, 10, 3, 56, 31g	 70, 10, 3, 14, 56, 31g	 73, 10, 7, 10.5, 7, 56, 35g	 73, 10, 7, 10.5, 7, 56, 34g	 77, 10, 7, 16, 11, 49.5, 38g	 77, 10, 7, 16, 11, 49.5, 37g
ADJUSTABLE ENERGY	 73, 1.3, 8, 15, 2.5, 5, 10, 3, 7, 56, 34g	 77, 10, 3, 14, 56, 34g	 80, 10, 7, 10.5, 7, 56, 38g	 80, 10, 7, 10.5, 7, 56, 37g	 84, 10, 7, 16, 11, 49.5, 41g	 84, 10, 7, 16, 11, 49.5, 40g



# INDUSTRIAL SHOCK ABSORBERS POWERSTOP

## THREAD M12X1

### ACCESSORIES

Pos.	Order no.	Accessories	Remarks
①	<b>PAH12X10-A</b>	Stop sleeve	Including 1x PVM12X10-A. Industrial shock absorber with bellow excluded.
②	<b>PSH12X10-B</b>	Sensor stop sleeve	Including 1x PVM12X10-A. Sensing only possible via industrial shock absorbers with steel or plastic head. Industrial shock absorber with bellow excluded. Inductive sensor, PNP (NC), 2 m PUR cable, IP67 degree of protection. See separate data sheet for additional information.
③	<b>PBV12X10ND-A</b>	Side load adapter standard stroke Protection: no protection	Impact angle max. 30°. Can only be used in combination with industrial shock absorber without protection and without the Short piston rod no head variant. Lock nut PVM16X10-A suitable for external thread of the side load adapter.
④	<b>PBV12X10NF-A</b>	Side load adapter standard stroke Protection: felt ring (felt)	Impact angle max. 30°. Can only be used in combination with industrial shock absorber without protection and without the Short piston rod no head variant. Lock nut PVM16X10-A suitable for external thread of the side load adapter.
⑤	<b>PBV12X10NA-A</b>	Side load adapter standard stroke Protection: wiper (NBR)	Impact angle max. 30°. Can only be used in combination with industrial shock absorber without protection and without the Short piston rod no head variant. Lock nut PVM16X10-A suitable for external thread of the side load adapter.
⑥	<b>PKS12X10-A</b>	Clamping flange orthogonal screwed	Tightening torque of the screws max. 3 Nm.
⑦	<b>PKP12X10-A</b>	Clamping flange screwed in parallel	Tightening torque of the screws max. 1 Nm.
⑧	<b>PVM12X10-A</b>	Stainless steel locknut	Included with the industrial shock absorber.
⑨	<b>PDD12X10-A</b>	Pressure chamber seal	Recommended fixation with PVM12X10-A. Seal must be in full contact on both sides.

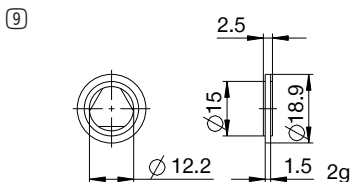
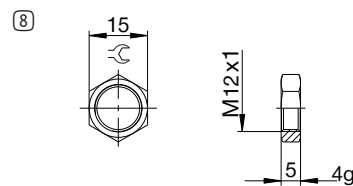
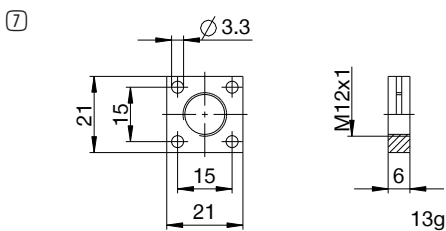
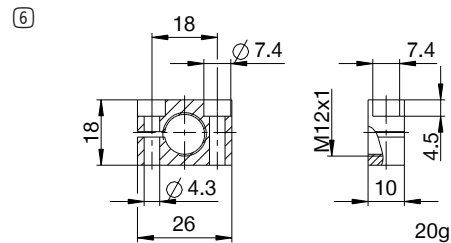
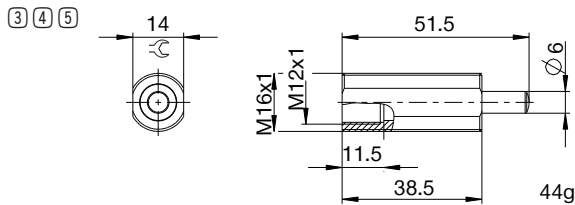
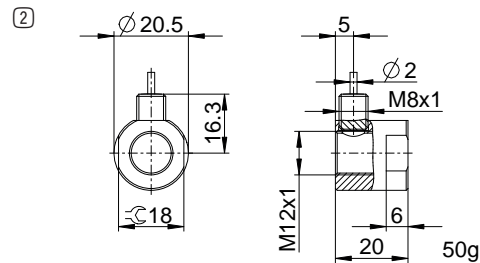
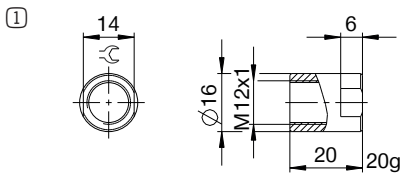

## ▶ CLASSIFICATION

**P** **HE** **12X10** **N** **H** **A** **K** **-A**

### Design

**P** Industrial shock absorbers PowerStop

### Series

**ME** Mini Energy

**SE** Standard Energy

**HE** High Energy

**AE** Adjustable Energy

### Thread

**12** Thread nominal diameter

**X**

**10** Thread pitch (factor 10)

### Stroke variant

**N** Standard stroke

**L** Long stroke

### Hardness degree

**H** Hard (0.1 - 1.2 m/s; Adjustable Energy: 0.1 - 5 m/s)

**M** Medium (0.8 - 2.2 m/s)

**S** Soft (1.8 - 3.5 m/s)

**W** Supersoft (3 - 5 m/s)

### Protection

**D** no protection

**F** Felt ring

**A** Wiper (NBR)

**B** Bellow (TPE)

### Head

**D** Short piston rod no head

**E** Long piston rod no head

**S** with steel head

**K** with plastic head

### Version

**-A** Versioning from a to z

# INDUSTRIAL SHOCK ABSORBERS POWERSTOP THREAD M14X1

## ► SERIES

PowerStop®



► <b>Material</b>	Stainless steel	► <b>Organic oil (biodegradable)</b>	HEES
► <b>Permitted temperature range</b>	-10 ... +70 [°C]	- <b>H1-certified</b>	Yes
► <b>Angle of Impact max.</b>	2 [°]	- <b>PWIS-free</b>	Yes
► <b>Max. force at fixed stop</b>	3.5 [kN]	► <b>RoHS compliant</b> - <b>REACH compliant</b>	Yes
► <b>Lock nut tightening torque</b>		► <b>Max. absolute pressure</b>	
- <b>Standard energy</b>	15 [Nm]	- <b>Standard energy</b>	1 [bar]
- <b>High Energy</b>	20 [Nm]	- <b>High Energy</b>	10 [bar]
- <b>Adjustable Energy</b>	20 [Nm]	- <b>Adjustable Energy</b>	10 [bar]

## ► TECHNICAL DATA

	Design	Series	Thread	Stroke variant	Stroke max. [mm]	Hardness degree	Impact velocity		Energy absorption max.			Protection	Reset			Head Integrated stop	Version		
							min. [m/s]	max. [m/s]	Continuous operation		Emergency stop operation per stroke [J]		Force		Time max. [s]				
									per stroke [J]	per hour [J/h]			min. [N]	max. [N]					
STANDARD ENERGY	P	SE	14X10	N	12	H	0,1	1,2	20	50.000	20	D	3	6	0,3	D	x	-A	
							M	0,8	2,2	20	50.000	20	F	3	6	0,3	E		-
							S	1,8	3,5	20	50.000	20	A	3	6	0,3	S		x
							W	3,0	5,0	20	50.000	20	B	3	15	0,3	K		x
HIGH ENERGY	P	HE	14X10	N	12	H	0,1	1,2	34	50.000	42	D	7	11	0,3	D	x	-A	
							M	0,8	2,2	32	50.000	38	F	7	11	0,3	E		-
							S	1,8	3,5	30	50.000	34	A	7	11	0,3	S		x
							W	3,0	5,0	28	50.000	30	B	7	20	0,3	K		x
ADJUSTABLE ENERGY	P	AE	14X10	N	12	H	0,1	5,0	34	50.000	34	D	7	11	0,3	D	x	-A	
							M	0,8	2,2	32	50.000	38	F	7	11	0,3	E		-
							S	1,8	3,5	30	50.000	34	A	7	11	0,3	S		x
							W	3,0	5,0	28	50.000	30	B	7	20	0,3	K		x
HIGH ENERGY	P	HE	14X10	L	20	H	0,1	1,2	34	50.000	42	D	7	11	0,4	D	x	-A	
							M	0,8	2,2	32	50.000	38	F	7	11	0,4	E		-
							S	1,8	3,5	30	50.000	34	A	7	11	0,4	S		x
							W	3,0	5,0	28	50.000	30	A	7	11	0,4	K		x
ADJUSTABLE ENERGY	P	AE	14X10	L	20	H	0,1	5,0	34	50.000	34	D	7	11	0,4	D	x	-A	
							M	0,8	2,2	32	50.000	38	F	7	11	0,4	E		-
							S	1,8	3,5	30	50.000	34	A	7	11	0,4	S		x
							W	3,0	5,0	28	50.000	30	A	7	11	0,4	K		x

## PROTECTION

no protection D -A	Felt ring F -A	Wiper (NBR) A -A	Bellow (TPE) B -A
in a clean environment	against dust, chips, ...	against liquid, oil, ...	

## TECHNICAL DRAWINGS

	Short piston rod no head N D -A	Long piston rod no head N E -A	with steel head N S -A	with plastic head N K -A	with bellow and steel head N B S -A	with bellow and plastic head N B K -A
STANDARD ENERGY	 76, 10, 17, 4, 3, 6, 12, 64, 53g	 81, 12, 4, 17, 64, 54g	 85, 12, 8.5, 12, 9, 64, 60g	 85, 12, 8.5, 12, 9, 64, 59g	 91.5, 12, 8.5, 19, 15.5, 56, 66g	 91.5, 12, 8.5, 19, 15.5, 56, 65g
HIGH ENERGY	 75, 10, 17, 4, 3, 6, 12, 63, 53g	 80, 12, 4, 17, 63, 54g	 84, 12, 8.5, 12, 9, 63, 60g	 84, 12, 8.5, 12, 9, 63, 59g	 90.5, 12, 8.5, 19, 15.5, 55, 66g	 90.5, 12, 8.5, 19, 15.5, 55, 65g
ADJUSTABLE ENERGY	 83, 1.5, 10, 17, 4, 3, 6, 12, 8, 63, 56g	 88, 12, 4, 17, 63, 57g	 92, 12, 8.5, 12, 9, 63, 63g	 92, 12, 8.5, 12, 9, 63, 62g	 98.5, 12, 8.5, 19, 15.5, 55, 69g	 98.5, 12, 8.5, 19, 15.5, 55, 68g

	Short piston rod no head L D -A	Long piston rod no head L E -A	with steel head L S -A	with plastic head L K -A
HIGH ENERGY	 102, 10, 17, 4, 3, 6, 20, 82, 69g	 107, 20, 4, 25, 82, 70g	 111, 20, 8.5, 12, 9, 82, 76g	 111, 20, 8.5, 12, 9, 82, 75g
ADJUSTABLE ENERGY	 110, 1.5, 10, 17, 4, 3, 6, 20, 8, 82, 74g	 115, 20, 4, 25, 82, 75g	 119, 20, 8.5, 12, 9, 82, 81g	 119, 20, 8.5, 12, 9, 82, 80g



# INDUSTRIAL SHOCK ABSORBERS POWERSTOP THREAD M14X1

## ▶ ACCESSORIES

Pos.	Order no.	Accessories	Remarks
①	<b>PAH14X10-A</b>	Stop sleeve	Including 1x PVM14X10-A. Industrial shock absorber with bellow excluded.
②	<b>PSH14X10-B</b>	Sensor stop sleeve	Including 1x PVM14X10-A. Sensing only possible via industrial shock absorbers with steel or plastic head. Industrial shock absorber with bellow excluded. Inductive sensor, PNP (NC), 2 m PUR cable, IP67 degree of protection. See separate data sheet for additional information.
③	<b>PBV14X10ND-A</b>	Side load adapter standard stroke Protection: no protection	Impact angle max. 30°. Can only be used in combination with industrial shock absorber without protection and without the Short piston rod no head variant. Lock nut PVM20X15-A suitable for external thread of the side load adapter.
④	<b>PBV14X10NF-A</b>	Side load adapter standard stroke Protection: felt ring (felt)	Impact angle max. 30°. Can only be used in combination with industrial shock absorber without protection and without the Short piston rod no head variant. Lock nut PVM20X15-A suitable for external thread of the side load adapter.
⑤	<b>PBV14X10NA-A</b>	Side load adapter standard stroke Protection: wiper (NBR)	Impact angle max. 30°. Can only be used in combination with industrial shock absorber without protection and without the Short piston rod no head variant. Lock nut PVM20X15-A suitable for external thread of the side load adapter.
⑥	<b>PBV14X10LD-A</b>	Side load adapter long stroke Protection: no protection	Impact angle max. 30°. Can only be used in combination with industrial shock absorber without protection and without the Short piston rod no head variant. Lock nut PVM20X15-A suitable for external thread of the side load adapter.
⑦	<b>PBV14X10LF-A</b>	Side load adapter long stroke Protection: felt ring (felt)	Impact angle max. 30°. Can only be used in combination with industrial shock absorber without protection and without the Short piston rod no head variant. Lock nut PVM20X15-A suitable for external thread of the side load adapter.
⑧	<b>PBV14X10LA-A</b>	Side load adapter long stroke Protection: wiper (NBR)	Impact angle max. 30°. Can only be used in combination with industrial shock absorber without protection and without the Short piston rod no head variant. Lock nut PVM20X15-A suitable for external thread of the side load adapter.
⑨	<b>PKS14X10-A</b>	Clamping flange orthogonal screwed	Tightening torque of the screws max. 5 Nm.
⑩	<b>PKP14X10-A</b>	Clamping flange screwed in parallel	Tightening torque of the screws max. 3 Nm.
⑪	<b>PVM14X10-A</b>	Stainless steel locknut	Included with the industrial shock absorber.
⑫	<b>PDD14X10-A</b>	Pressure chamber seal	Recommended fixation with PVM14X10-A. Seal must be in full contact on both sides.

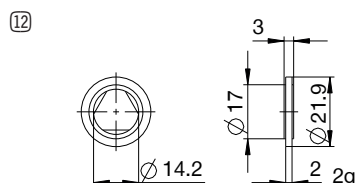
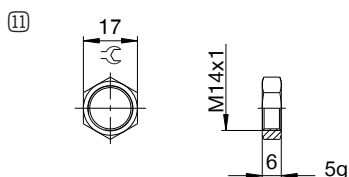
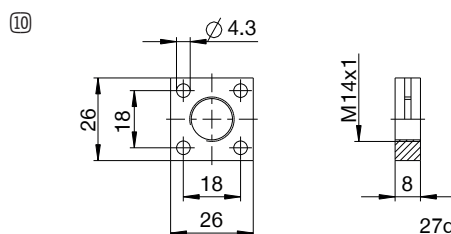
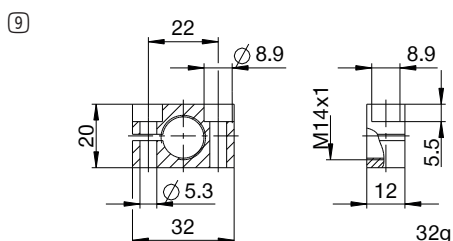
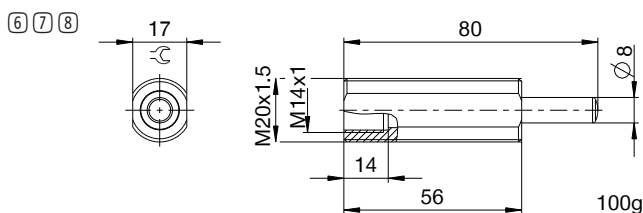
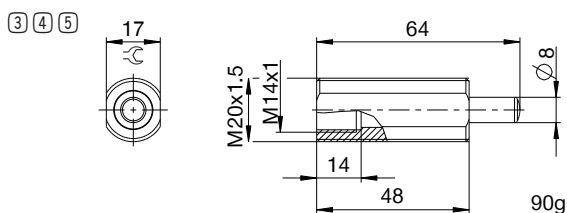
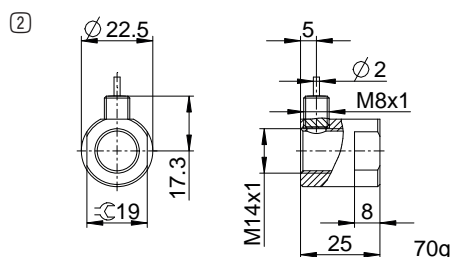
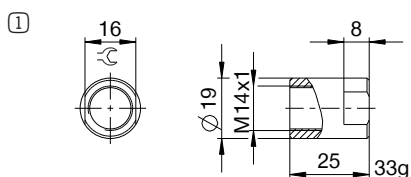



## ▶ CLASSIFICATION

P HE 14X10 L H A K -A

### Design

**P** Industrial shock absorbers PowerStop

### Series

**ME** Mini Energy

**SE** Standard Energy

**HE** High Energy

**AE** Adjustable Energy

### Thread

**14** Thread nominal diameter

**X**

**10** Thread pitch (factor 10)

### Stroke variant

**N** Standard stroke

**L** Long stroke

### Hardness degree

**H** Hard (0.1 - 1.2 m/s; Adjustable Energy: 0.1 - 5 m/s)

**M** Medium (0.8 - 2.2 m/s)

**S** Soft (1.8 - 3.5 m/s)

**W** Supersoft (3 - 5 m/s)

### Protection

**D** no protection

**F** Felt ring

**A** Wiper (NBR)

**B** Bellow (TPE)

### Head

**D** Short piston rod no head

**E** Long piston rod no head

**S** with steel head

**K** with plastic head

### Version

**-A** Versioning from a to z

# INDUSTRIAL SHOCK ABSORBERS POWERSTOP

## THREAD M14X1.5

### ► SERIES

PowerStop®

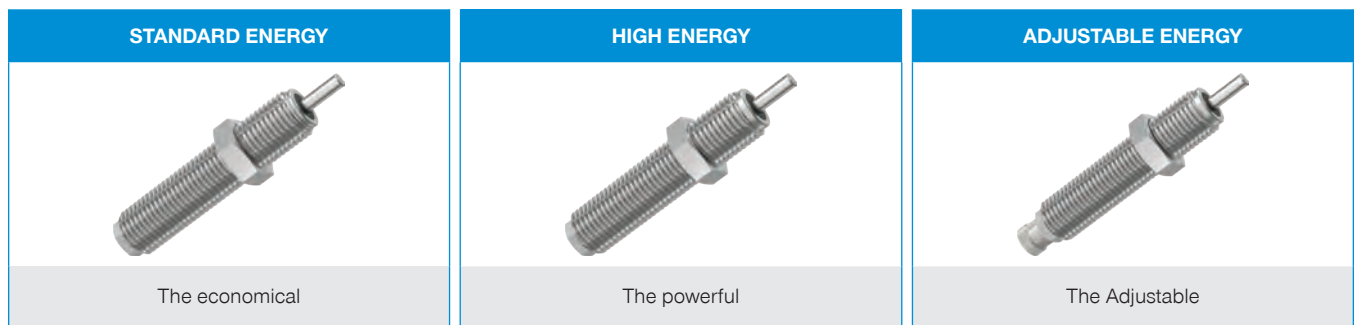

► <b>Material</b>	Stainless steel	► <b>Organic oil (biodegradable)</b>	HEES
► <b>Permitted temperature range</b>	-10 ... +70 [°C]	- <b>H1-certified</b>	Yes
► <b>Angle of Impact max.</b>	2 [°]	- <b>PWIS-free</b>	Yes
► <b>Max. force at fixed stop</b>	3.5 [kN]	► <b>RoHS compliant</b> - <b>REACH compliant</b>	Yes
► <b>Lock nut tightening torque</b>		► <b>Max. absolute pressure</b>	
- <b>Standard energy</b>	15 [Nm]	- <b>Standard energy</b>	1 [bar]
- <b>High Energy</b>	20 [Nm]	- <b>High Energy</b>	10 [bar]
- <b>Adjustable Energy</b>	20 [Nm]	- <b>Adjustable Energy</b>	10 [bar]

### ► TECHNICAL DATA

	Design	Series	Thread	Stroke variant	Stroke	Hardness degree	Impact velocity			Energy absorption max.			Protection	Reset			Head	Integrated Fix stop	Version
							min.	max.	per stroke	per hour	per stroke	min.		max.	Time				
																[m/s]			
STANDARD ENERGY	P	SE	14X15	N	12	H	0,1	1,2	20	50.000	20	D	3	6	0,3	D	x	-A	
							M	0,8	2,2	20	50.000	20	F	3	6	0,3	E		-
							S	1,8	3,5	20	50.000	20	A	3	6	0,3	S		x
							W	3,0	5,0	20	50.000	20	B	3	15	0,3	K		x
HIGH ENERGY	P	HE	14X15	N	12	H	0,1	1,2	34	50.000	42	D	7	11	0,3	D	x	-A	
							M	0,8	2,2	32	50.000	38	F	7	11	0,3	E		-
							S	1,8	3,5	30	50.000	34	A	7	11	0,3	S		x
							W	3,0	5,0	28	50.000	30	B	7	20	0,3	K		x
ADJUSTABLE ENERGY	P	AE	14X15	N	12	H	0,1	5,0	34	50.000	34	D	7	11	0,3	D	x	-A	
							M	0,8	2,2	32	50.000	38	F	7	11	0,3	E		-
							S	1,8	3,5	30	50.000	34	A	7	11	0,3	S		x
							W	3,0	5,0	28	50.000	30	B	7	20	0,3	K		x
HIGH ENERGY	P	HE	14X15	L	20	H	0,1	1,2	34	50.000	42	D	7	11	0,4	D	x	-A	
							M	0,8	2,2	32	50.000	38	F	7	11	0,4	E		-
							S	1,8	3,5	30	50.000	34	A	7	11	0,4	S		x
							W	3,0	5,0	28	50.000	30	A	7	11	0,4	K		x
ADJUSTABLE ENERGY	P	AE	14X15	L	20	H	0,1	5,0	34	50.000	34	D	7	11	0,4	D	x	-A	
							M	0,8	2,2	32	50.000	38	F	7	11	0,4	E		-
							S	1,8	3,5	30	50.000	34	A	7	11	0,4	S		x
							W	3,0	5,0	28	50.000	30	A	7	11	0,4	K		x

## PROTECTION

no protection	Felt ring	Wiper (NBR)	Bellow (TPE)
D -A	F -A	A -A	B -A
in a clean environment	against dust, chips, ...	against liquid, oil, ...	

## TECHNICAL DRAWINGS

	Short piston rod no head	Long piston rod no head	with steel head	with plastic head	with bellow and steel head	with bellow and plastic head
	N D -A	N E -A	N S -A	N K -A	N B S -A	N B K -A
STANDARD ENERGY						
HIGH ENERGY						
ADJUSTABLE ENERGY						

	Short piston rod no head	Long piston rod no head	with steel head	with plastic head
	L D -A	L E -A	L S -A	L K -A
HIGH ENERGY				
ADJUSTABLE ENERGY				



# INDUSTRIAL SHOCK ABSORBERS POWERSTOP

## THREAD M14X1.5

### ▶ ACCESSORIES

Pos.	Order no.	Accessories	Remarks
①	<b>PAH14X15-A</b>	Stop sleeve	Including 1x PVM14X15-A. Industrial shock absorber with bellow excluded.
②	<b>PSH14X15-B</b>	Sensor stop sleeve	Including 1x PVM14X15-A. Sensing only possible via industrial shock absorbers with steel or plastic head. Industrial shock absorber with bellow excluded. Inductive sensor, PNP (NC), 2 m PUR cable, IP67 degree of protection. See separate data sheet for additional information.
③	<b>PBV14X15ND-A</b>	Side load adapter standard stroke Protection: no protection	Impact angle max. 30°. Can only be used in combination with industrial shock absorber without protection and without the Short piston rod no head variant. Lock nut PVM20X15-A suitable for external thread of the side load adapter.
④	<b>PBV14X15NF-A</b>	Side load adapter standard stroke Protection: felt ring (felt)	Impact angle max. 30°. Can only be used in combination with industrial shock absorber without protection and without the Short piston rod no head variant. Lock nut PVM20X15-A suitable for external thread of the side load adapter.
⑤	<b>PBV14X15NA-A</b>	Side load adapter standard stroke Protection: wiper (NBR)	Impact angle max. 30°. Can only be used in combination with industrial shock absorber without protection and without the Short piston rod no head variant. Lock nut PVM20X15-A suitable for external thread of the side load adapter.
⑥	<b>PBV14X15LD-A</b>	Side load adapter long stroke Protection: no protection	Impact angle max. 30°. Can only be used in combination with industrial shock absorber without protection and without the Short piston rod no head variant. Lock nut PVM20X15-A suitable for external thread of the side load adapter.
⑦	<b>PBV14X15LF-A</b>	Side load adapter long stroke Protection: felt ring (felt)	Impact angle max. 30°. Can only be used in combination with industrial shock absorber without protection and without the Short piston rod no head variant. Lock nut PVM20X15-A suitable for external thread of the side load adapter.
⑧	<b>PBV14X15LA-A</b>	Side load adapter long stroke Protection: wiper (NBR)	Impact angle max. 30°. Can only be used in combination with industrial shock absorber without protection and without the Short piston rod no head variant. Lock nut PVM20X15-A suitable for external thread of the side load adapter.
⑨	<b>PKS14X15-A</b>	Clamping flange orthogonal screwed	Tightening torque of the screws max. 5 Nm.
⑩	<b>PKP14X15-A</b>	Clamping flange screwed in parallel	Tightening torque of the screws max. 3 Nm.
⑪	<b>PVM14X15-A</b>	Stainless steel locknut	Included with the industrial shock absorber.
⑫	<b>PDD14X15-A</b>	Pressure chamber seal	Recommended fixation with PVM14X15-A. Seal must be in full contact on both sides.

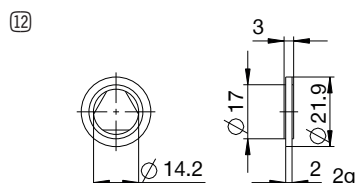
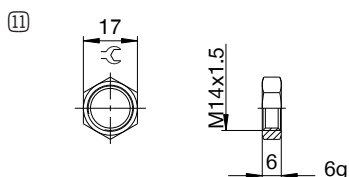
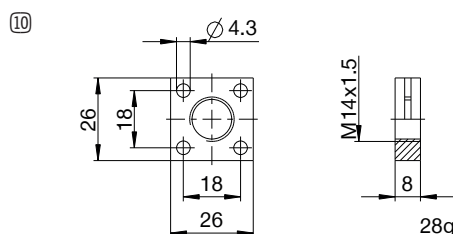
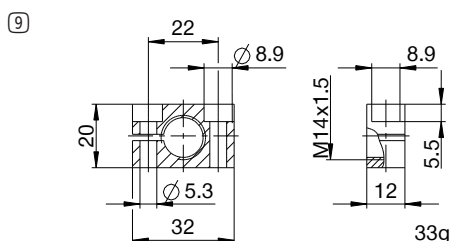
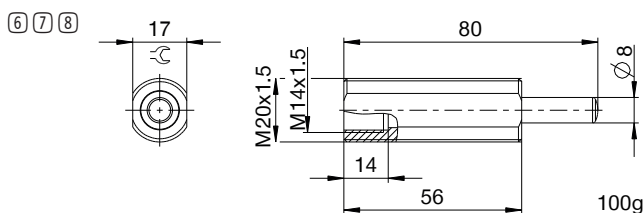
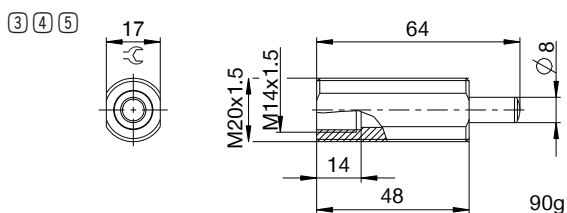
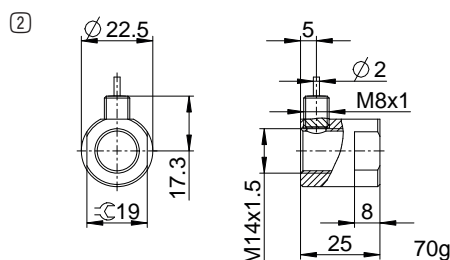
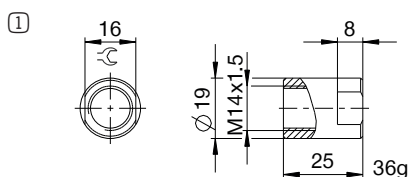

## ▶ CLASSIFICATION

P HE 14X15 L H A K -A

### Design

**P** Industrial shock absorbers PowerStop

### Series

**ME** Mini Energy

**SE** Standard Energy

**HE** High Energy

**AE** Adjustable Energy

### Thread

**14** Thread nominal diameter

**X**

**15** Thread pitch (factor 10)

### Stroke variant

**N** Standard stroke

**L** Long stroke

### Hardness degree

**H** Hard (0.1 - 1.2 m/s; Adjustable Energy: 0.1 - 5 m/s)

**M** Medium (0.8 - 2.2 m/s)

**S** Soft (1.8 - 3.5 m/s)

**W** Supersoft (3 - 5 m/s)

### Protection

**D** no protection

**F** Felt ring

**A** Wiper (NBR)

**B** Bellow (TPE)

### Head

**D** Short piston rod no head

**E** Long piston rod no head

**S** with steel head

**K** with plastic head

### Version

**-A** Versioning from a to z

# INDUSTRIAL SHOCK ABSORBERS POWERSTOP THREAD M16X1

## ► SERIES

PowerStop®



► <b>Material</b>	Stainless steel	► <b>Organic oil (biodegradable)</b>	HEES
► <b>Permitted temperature range</b>	-10 ... +70 [°C]	- <b>H1-certified</b>	Yes
► <b>Angle of Impact max.</b>	2 [°]	- <b>PWIS-free</b>	Yes
► <b>Max. force at fixed stop</b>	3.5 [kN]	► <b>RoHS compliant</b> - <b>REACH compliant</b>	Yes
► <b>Lock nut tightening torque</b>		► <b>Max. absolute pressure</b>	
- <b>Standard energy</b>	15 [Nm]	- <b>Standard energy</b>	1 [bar]
- <b>High Energy</b>	20 [Nm]	- <b>High Energy</b>	10 [bar]
- <b>Adjustable Energy</b>	20 [Nm]	- <b>Adjustable Energy</b>	10 [bar]

## ► TECHNICAL DATA

	Design	Series	Thread	Stroke variant	Stroke max. [mm]	Hardness degree	Impact velocity			Energy absorption max.			Protection	Reset			Head Integrated stop	Version		
							min.	max.	per stroke [J]	per hour [J/h]	per stroke [J]	Force min. [N]		Force max. [N]	Time max. [s]					
																min.			max.	per stroke
STANDARD ENERGY	P	SE	16X10	N	12	H	0,1	1,2	20	50.000	20	D	3	6	0,3	D	x			
							M	0,8	2,2	20	50.000	20	-	-	-	-	-	-	-	-
								S	1,8	3,5	20	50.000	20	F	3	6	0,3	S	x	
									W	3,0	5,0	20	50.000	20	A	3	6	0,3	K	x
HIGH ENERGY	P	HE	16X10	N	12	H	0,1	1,2	34	50.000	42	D	7	11	0,3	D	x			
							M	0,8	2,2	32	50.000	38	-	-	-	-	-	-	-	
								S	1,8	3,5	30	50.000	34	F	7	11	0,3	S	x	
									W	3,0	5,0	28	50.000	30	A	7	11	0,3	K	x
ADJUSTABLE ENERGY	P	AE	16X10	N	12	H	0,1	5,0	34	50.000	34	D	7	11	0,3	D	x			
							M	0,8	2,2	32	50.000	38	-	-	-	-	-	-	-	
								S	1,8	3,5	30	50.000	34	F	7	11	0,3	S	x	
									W	3,0	5,0	28	50.000	30	A	7	11	0,3	K	x
HIGH ENERGY	P	HE	16X10	L	20	H	0,1	1,2	34	50.000	42	D	7	11	0,4	D	x			
							M	0,8	2,2	32	50.000	38	-	-	-	-	-	-	-	
								S	1,8	3,5	30	50.000	34	F	7	11	0,4	S	x	
									W	3,0	5,0	28	50.000	30	A	7	11	0,4	K	x
ADJUSTABLE ENERGY	P	AE	16X10	L	20	H	0,1	5,0	34	50.000	34	D	7	11	0,4	D	x			
							M	0,8	2,2	32	50.000	38	-	-	-	-	-	-	-	
								S	1,8	3,5	30	50.000	34	F	7	11	0,4	S	x	
									W	3,0	5,0	28	50.000	30	A	7	11	0,4	K	x

## PROTECTION

no protection	Felt ring	Wiper (NBR)
D -A	F -A	A -A
in a clean environment	against dust, chips, ...	against liquid, oil, ...

## TECHNICAL DRAWINGS

	Short piston rod no head	Long piston rod no head	with steel head	with plastic head
	N D -A	N E -A	N S -A	N K -A
STANDARD ENERGY				
HIGH ENERGY				
ADJUSTABLE ENERGY				

	Short piston rod no head	Long piston rod no head	with steel head	with plastic head
	L D -A	L E -A	L S -A	L K -A
HIGH ENERGY				
ADJUSTABLE ENERGY				



# INDUSTRIAL SHOCK ABSORBERS POWERSTOP THREAD M16X1

## ▶ ACCESSORIES

Pos.	Order no.	Accessories	Remarks
①	<b>PAH16X10-A</b>	Stop sleeve	Including 1x PVM16X10-A. Industrial shock absorber with bellow excluded.
②	<b>PBV16X10ND-A</b>	Side load adapter standard stroke Protection: no protection	Impact angle max. 30°. Can only be used in combination with industrial shock absorber without protection and without the Short piston rod no head variant. Lock nut PVM22X15-A suitable for external thread of the side load adapter.
③	<b>PBV16X10NF-A</b>	Side load adapter standard stroke Protection: felt ring (felt)	Impact angle max. 30°. Can only be used in combination with industrial shock absorber without protection and without the Short piston rod no head variant. Lock nut PVM22X15-A suitable for external thread of the side load adapter.
④	<b>PBV16X10NA-A</b>	Side load adapter standard stroke Protection: wiper (NBR)	Impact angle max. 30°. Can only be used in combination with industrial shock absorber without protection and without the Short piston rod no head variant. Lock nut PVM22X15-A suitable for external thread of the side load adapter.
⑤	<b>PBV16X10LD-A</b>	Side load adapter long stroke Protection: no protection	Impact angle max. 30°. Can only be used in combination with industrial shock absorber without protection and without the Short piston rod no head variant. Lock nut PVM22X15-A suitable for external thread of the side load adapter.
⑥	<b>PBV16X10LF-A</b>	Side load adapter long stroke Protection: felt ring (felt)	Impact angle max. 30°. Can only be used in combination with industrial shock absorber without protection and without the Short piston rod no head variant. Lock nut PVM22X15-A suitable for external thread of the side load adapter.
⑦	<b>PBV16X10LA-A</b>	Side load adapter long stroke Protection: wiper (NBR)	Impact angle max. 30°. Can only be used in combination with industrial shock absorber without protection and without the Short piston rod no head variant. Lock nut PVM22X15-A suitable for external thread of the side load adapter.
⑧	<b>PKS16X10-A</b>	Clamping flange orthogonal screwed	Tightening torque of the screws max. 5 Nm.
⑨	<b>PKP16X10-A</b>	Clamping flange screwed in parallel	Tightening torque of the screws max. 3 Nm.
⑩	<b>PVM16X10-A</b>	Stainless steel locknut	Included with the industrial shock absorber.
⑪	<b>PDD16X10-A</b>	Pressure chamber seal	On request. Recommended fixing with PVM16x10-A. Seal must be in full contact on both sides.

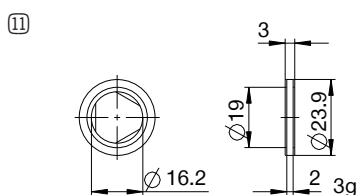
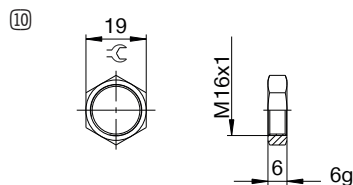
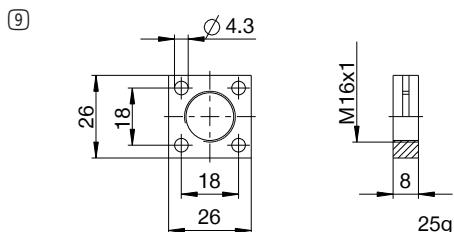
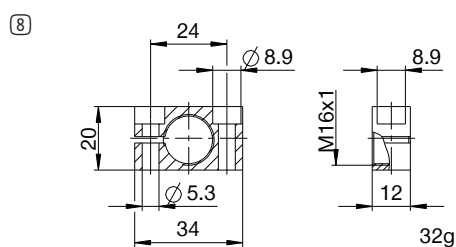
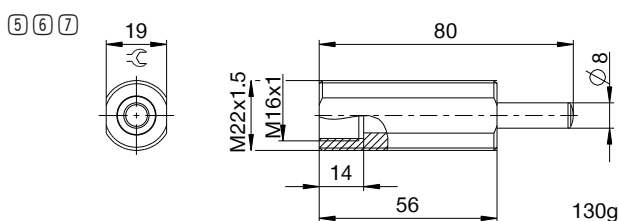
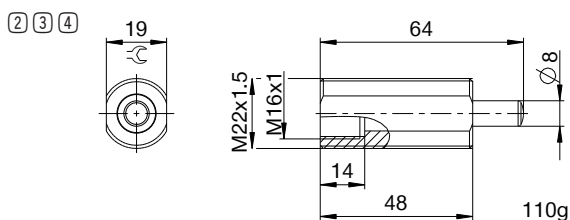
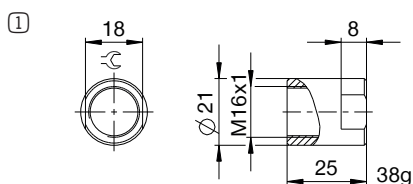



## ▶ CLASSIFICATION

P HE 16X1 L H A K -A

### Design

**P** Industrial shock absorbers PowerStop

### Series

**ME** Mini Energy

**SE** Standard Energy

**HE** High Energy

**AE** Adjustable Energy

### Thread

**16** Thread nominal diameter

**X**

**10** Thread pitch (factor 10)

### Stroke variant

**N** Standard stroke

**L** Long stroke

### Hardness degree

**H** Hard (0.1 - 1.2 m/s; Adjustable Energy: 0.1 - 5 m/s)

**M** Medium (0.8 - 2.2 m/s)

**S** Soft (1.8 - 3.5 m/s)

**W** Supersoft (3 - 5 m/s)

### Protection

**D** no protection

**F** Felt ring

**A** Wiper (NBR)

**B** Bellow (TPE)

### Head

**D** Short piston rod no head

**E** Long piston rod no head

**S** with steel head

**K** with plastic head

### Version

**-A** Versioning from a to z

# INDUSTRIAL SHOCK ABSORBERS POWERSTOP

## THREAD M16X1.5

### ► SERIES

PowerStop®

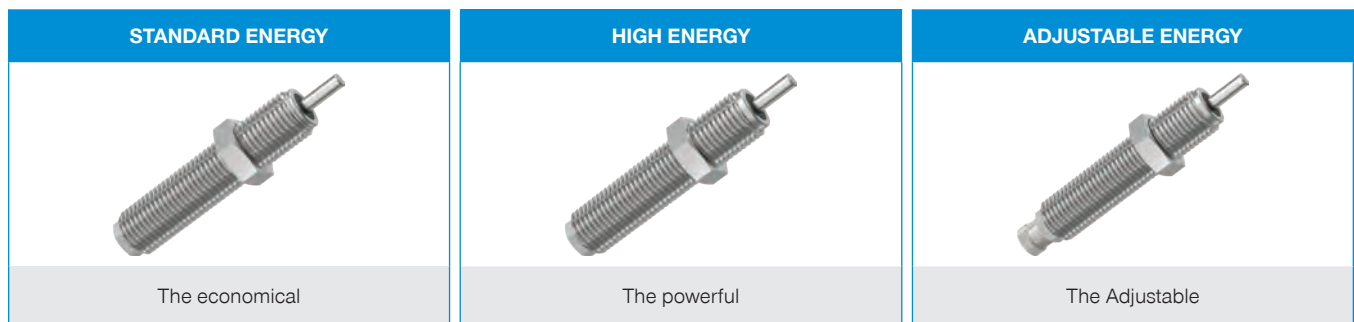

► <b>Material</b>	Stainless steel	► <b>Organic oil (biodegradable)</b>	HEES
► <b>Permitted temperature range</b>	-10 ... +70 [°C]	- <b>H1-certified</b>	Yes
► <b>Angle of Impact max.</b>	2 [°]	- <b>PWIS-free</b>	Yes
► <b>Max. force at fixed stop</b>	3.5 [kN]	► <b>RoHS compliant</b> - <b>REACH compliant</b>	Yes
► <b>Lock nut tightening torque</b>		► <b>Max. absolute pressure</b>	
- <b>Standard energy</b>	15 [Nm]	- <b>Standard energy</b>	1 [bar]
- <b>High Energy</b>	20 [Nm]	- <b>High Energy</b>	10 [bar]
- <b>Adjustable Energy</b>	20 [Nm]	- <b>Adjustable Energy</b>	10 [bar]

### ► TECHNICAL DATA

	Design	Series	Thread	Stroke variant	Stroke max. [mm]	Hardness degree	Impact velocity		Energy absorption max.			Protection	Reset			Head	Integrated Fix stop	Version	
							min.	max.	Continuous operation		Emergency stop operation		Force min. [N]	Time max. [s]					
									per stroke [J]	per hour [J/h]					per stroke [J]				
STANDARD ENERGY	P	SE	16X15	N	12	H	0,1	1,2	20	50.000	20	D	3	6	0,3	D	x	-A	
							M	0,8	2,2	20	50.000	20	F	3	6	0,3	E		-
							S	1,8	3,5	20	50.000	20	-	-	-	-	S		x
							W	3,0	5,0	20	50.000	20	A	3	6	0,3	K		x
HIGH ENERGY	P	HE	16X15	N	12	H	0,1	1,2	34	50.000	42	D	7	11	0,3	D	x	-A	
							M	0,8	2,2	32	50.000	38	F	7	11	0,3	E		-
							S	1,8	3,5	30	50.000	34	-	-	-	-	S		x
							W	3,0	5,0	28	50.000	30	A	7	11	0,3	K		x
ADJUSTABLE ENERGY	P	AE	16X15	N	12	H	0,1	5,0	34	50.000	34	D	7	11	0,3	D	x	-A	
							M	0,8	2,2	32	50.000	38	F	7	11	0,3	E		-
							S	1,8	3,5	30	50.000	34	-	-	-	-	S		x
							W	3,0	5,0	28	50.000	30	A	7	11	0,3	K		x
HIGH ENERGY	P	HE	16X15	L	20	H	0,1	1,2	34	50.000	42	D	7	11	0,4	D	x	-A	
							M	0,8	2,2	32	50.000	38	F	7	11	0,4	E		-
							S	1,8	3,5	30	50.000	34	-	-	-	-	S		x
							W	3,0	5,0	28	50.000	30	A	7	11	0,4	K		x
ADJUSTABLE ENERGY	P	AE	16X15	L	20	H	0,1	5,0	34	50.000	34	D	7	11	0,4	D	x	-A	
							M	0,8	2,2	32	50.000	38	F	7	11	0,4	E		-
							S	1,8	3,5	30	50.000	34	-	-	-	-	S		x
							W	3,0	5,0	28	50.000	30	A	7	11	0,4	K		x

## PROTECTION

no protection	Felt ring	Wiper (NBR)
D -A	F -A	A -A
in a clean environment	against dust, chips, ...	against liquid, oil, ...

## TECHNICAL DRAWINGS

	Short piston rod no head	Long piston rod no head	with steel head	with plastic head
	N D -A	N E -A	N S -A	N K -A
STANDARD ENERGY				
HIGH ENERGY				
ADJUSTABLE ENERGY				

	Short piston rod no head	Long piston rod no head	with steel head	with plastic head
	L D -A	L E -A	L S -A	L K -A
HIGH ENERGY				
ADJUSTABLE ENERGY				



# INDUSTRIAL SHOCK ABSORBERS POWERSTOP

## THREAD M16X1.5

### ACCESSORIES

Pos.	Order no.	Accessories	Remarks
①	<b>PAH16X15-A</b>	Stop sleeve	Including 1x PVM16X15-A. Industrial shock absorber with bellow excluded.
②	<b>PBV16X15ND-A</b>	Side load adapter standard stroke Protection: no protection	Impact angle max. 30°. Can only be used in combination with industrial shock absorber without protection and without the Short piston rod no head variant. Lock nut PVM22X15-A suitable for external thread of the side load adapter.
③	<b>PBV16X15NF-A</b>	Side load adapter standard stroke Protection: felt ring (felt)	Impact angle max. 30°. Can only be used in combination with industrial shock absorber without protection and without the Short piston rod no head variant. Lock nut PVM22X15-A suitable for external thread of the side load adapter.
④	<b>PBV16X15NA-A</b>	Side load adapter standard stroke Protection: wiper (NBR)	Impact angle max. 30°. Can only be used in combination with industrial shock absorber without protection and without the Short piston rod no head variant. Lock nut PVM22X15-A suitable for external thread of the side load adapter.
⑤	<b>PBV16X15LD-A</b>	Side load adapter long stroke Protection: no protection	Impact angle max. 30°. Can only be used in combination with industrial shock absorber without protection and without the Short piston rod no head variant. Lock nut PVM22X15-A suitable for external thread of the side load adapter.
⑥	<b>PBV16X15LF-A</b>	Side load adapter long stroke Protection: felt ring (felt)	Impact angle max. 30°. Can only be used in combination with industrial shock absorber without protection and without the Short piston rod no head variant. Lock nut PVM22X15-A suitable for external thread of the side load adapter.
⑦	<b>PBV16X15LA-A</b>	Side load adapter long stroke Protection: wiper (NBR)	Impact angle max. 30°. Can only be used in combination with industrial shock absorber without protection and without the Short piston rod no head variant. Lock nut PVM22X15-A suitable for external thread of the side load adapter.
⑧	<b>PKS16X15-A</b>	Clamping flange orthogonal screwed	Tightening torque of the screws max. 5 Nm.
⑨	<b>PKP16X15-A</b>	Clamping flange screwed in parallel	Tightening torque of the screws max. 3 Nm.
⑩	<b>PVM16X15-A</b>	Stainless steel locknut	Included with the industrial shock absorber.
⑪	<b>PDD16X15-A</b>	Pressure chamber seal	On request. Recommended fixing with PVM16x15-A. Seal must be in full contact on both sides.

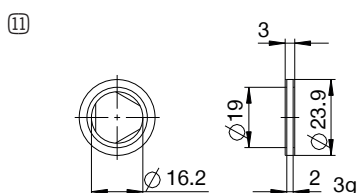
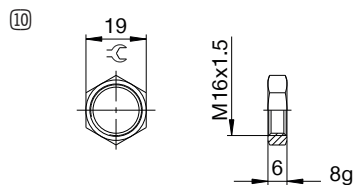
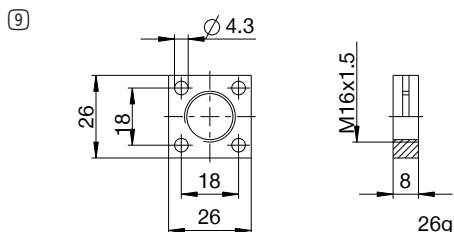
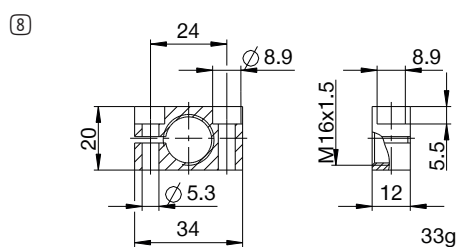
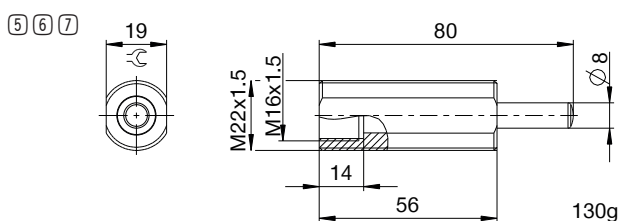
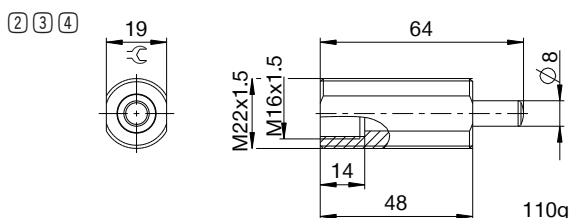
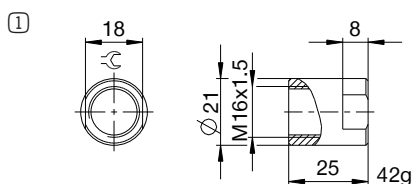

## ▶ CLASSIFICATION

P HE 16X15 L H A K -A

### Design

**P** Industrial shock absorbers PowerStop

### Series

**ME** Mini Energy

**SE** Standard Energy

**HE** High Energy

**AE** Adjustable Energy

### Thread

**16** Thread nominal diameter

**X**

**15** Thread pitch (factor 10)

### Stroke variant

**N** Standard stroke

**L** Long stroke

### Hardness degree

**H** Hard (0.1 - 1.2 m/s; Adjustable Energy: 0.1 - 5 m/s)

**M** Medium (0.8 - 2.2 m/s)

**S** Soft (1.8 - 3.5 m/s)

**W** Supersoft (3 - 5 m/s)

### Protection

**D** no protection

**F** Felt ring

**A** Wiper (NBR)

**B** Bellow (TPE)

### Head

**D** Short piston rod no head

**E** Long piston rod no head

**S** with steel head

**K** with plastic head

### Version

**-A** Versioning from a to z

# INDUSTRIAL SHOCK ABSORBERS POWERSTOP

## THREAD M20X1.5

### ► SERIES

PowerStop®



► <b>Material</b>	Stainless steel	► <b>Organic oil (biodegradable)</b>	HEES
► <b>Permitted temperature range</b>	-10 ... +70 [°C]	- <b>H1-certified</b>	Yes
► <b>Angle of Impact max.</b>	2 [°]	- <b>PWIS-free</b>	Yes
► <b>Max. force at fixed stop</b>	10 [kN]	► <b>RoHS compliant</b> - <b>REACH compliant</b>	Yes
► <b>Lock nut tightening torque</b>		► <b>Max. absolute pressure</b>	
- <b>Standard energy</b>	20 [Nm]	- <b>Standard energy</b>	1 [bar]
- <b>High Energy</b>	40 [Nm]	- <b>High Energy</b>	10 [bar]
- <b>Adjustable Energy</b>	40 [Nm]	- <b>Adjustable Energy</b>	10 [bar]

### ► TECHNICAL DATA

	Design	Series	Thread	Stroke variant	Stroke max. [mm]	Hardness degree	Impact velocity		Energy absorption max.			Protection	Reset			Head Integrated Fix stop	Version	
							min.	max.	Continuous operation		Emergency stop operation		Force min. [N]	Time max. [s]				
									per stroke [J]	per hour [J/h]					per stroke [J]			
STANDARD ENERGY	P	SE	20X15	N	15	H	0,1	1,2	41	90.000	41	D	7	15	0,3	D	x	
							M	0,8	2,2	41	90.000	41	F	7	15	0,3	E	-
							S	1,8	3,5	41	90.000	41	A	7	15	0,3	S	x
							W	3,0	5,0	41	90.000	41	B	7	52	0,3	K	x
HIGH ENERGY	P	HE	20X15	N	15	H	0,1	1,2	80	90.000	150	D	16	26	0,3	D	x	
							M	0,8	2,2	75	90.000	125	F	16	26	0,3	E	-
							S	1,8	3,5	70	90.000	100	A	16	26	0,3	S	x
							W	3,0	5,0	65	90.000	75	B	16	62	0,3	K	x
ADJUSTABLE ENERGY	P	AE	20X15	N	15	H	0,1	5,0	80	90.000	80	D	16	26	0,3	D	x	
							M	0,8	5,0	80	90.000	80	F	16	26	0,3	E	-
							S	1,8	5,0	80	90.000	80	A	16	26	0,3	S	x
							W	3,0	5,0	80	90.000	80	B	16	62	0,3	K	x
HIGH ENERGY	P	HE	20X15	L	25	H	0,1	1,2	80	90.000	150	D	16	26	0,5	D	x	
							M	0,8	2,2	75	90.000	125	-	16	26	0,5	E	-
							S	1,8	3,5	70	90.000	100	F	16	26	0,5	S	x
							W	3,0	5,0	65	90.000	75	A	16	26	0,5	K	x
ADJUSTABLE ENERGY	P	AE	20X15	L	25	H	0,1	5,0	80	90.000	80	D	16	26	0,5	D	x	
							M	0,8	5,0	80	90.000	80	F	16	26	0,5	E	-
							S	1,8	5,0	80	90.000	80	-	16	26	0,5	S	x
							W	3,0	5,0	80	90.000	80	A	16	26	0,5	K	x

## PROTECTION

no protection	Felt ring	Wiper (NBR)	Bellow (TPE)
D -A	F -A	A -A	B -A
in a clean environment	against dust, chips, ...	against liquid, oil, ...	

## TECHNICAL DRAWINGS

	Short piston rod no head	Long piston rod no head	with steel head	with plastic head	with bellow and steel head	with bellow and plastic head
	N D -A	N E -A	N S -A	N K -A	N B S -A	N B K -A
STANDARD ENERGY						
HIGH ENERGY						
ADJUSTABLE ENERGY						

	Short piston rod no head	Long piston rod no head	with steel head	with plastic head
	L D -A	L E -A	L S -A	L K -A
HIGH ENERGY				
ADJUSTABLE ENERGY				



# INDUSTRIAL SHOCK ABSORBERS POWERSTOP

## THREAD M20X1.5

### ▶ ACCESSORIES

Pos.	Order no.	Accessories	Remarks
①	<b>PAH20X15-A</b>	Stop sleeve	Including 1x PVM20X15-A. Industrial shock absorber with bellow excluded.
②	<b>PSH20X15-B</b>	Sensor stop sleeve	Including 1x PVM20X15-A. Sensing only possible via industrial shock absorbers with steel or plastic head. Industrial shock absorber with bellow excluded. Inductive sensor, PNP (NC), 2 m PUR cable, IP67 degree of protection. See separate data sheet for additional information.
③	<b>PBV20X15ND-A</b>	Side load adapter standard stroke Protection: no protection	Impact angle max. 30°. Can only be used in combination with industrial shock absorber without protection and without the Short piston rod no head variant. Lock nut PVM25X15-A suitable for external thread of the side load adapter.
④	<b>PBV20X15NF-A</b>	Side load adapter standard stroke Protection: felt ring (felt)	Impact angle max. 30°. Can only be used in combination with industrial shock absorber without protection and without the Short piston rod no head variant. Lock nut PVM25X15-A suitable for external thread of the side load adapter.
⑤	<b>PBV20X15NA-A</b>	Side load adapter standard stroke Protection: wiper (NBR)	Impact angle max. 30°. Can only be used in combination with industrial shock absorber without protection and without the Short piston rod no head variant. Lock nut PVM25X15-A suitable for external thread of the side load adapter.
⑥	<b>PBV20X15LD-A</b>	Side load adapter long stroke Protection: no protection	Impact angle max. 30°. Can only be used in combination with industrial shock absorber without protection and without the Short piston rod no head variant. Lock nut PVM25X15-A suitable for external thread of the side load adapter.
⑦	<b>PBV20X15LF-A</b>	Side load adapter long stroke Protection: felt ring (felt)	Impact angle max. 30°. Can only be used in combination with industrial shock absorber without protection and without the Short piston rod no head variant. Lock nut PVM25X15-A suitable for external thread of the side load adapter.
⑧	<b>PBV20X15LA-A</b>	Side load adapter long stroke Protection: wiper (NBR)	Impact angle max. 30°. Can only be used in combination with industrial shock absorber without protection and without the Short piston rod no head variant. Lock nut PVM25X15-A suitable for external thread of the side load adapter.
⑨	<b>PKS20X15-A</b>	Clamping flange orthogonal screwed	Tightening torque of the screws max. 10 Nm.
⑩	<b>PKP20X15-A</b>	Clamping flange screwed in parallel	Tightening torque of the screws max. 5 Nm.
⑪	<b>PVM20X15-A</b>	Stainless steel locknut	Included with the industrial shock absorber.
⑫	<b>PDD20X15-A</b>	Pressure chamber seal	Recommended fixation with PVM20X15-A. Seal must be in full contact on both sides.

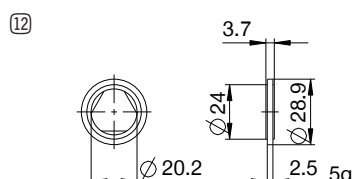
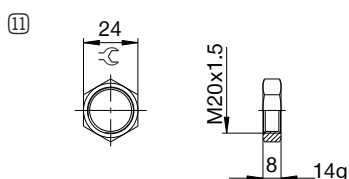
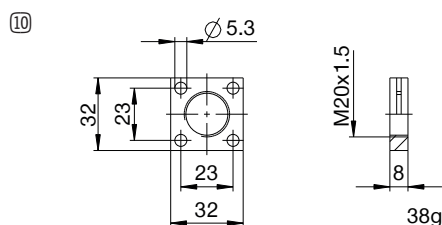
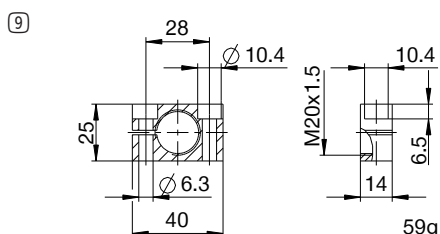
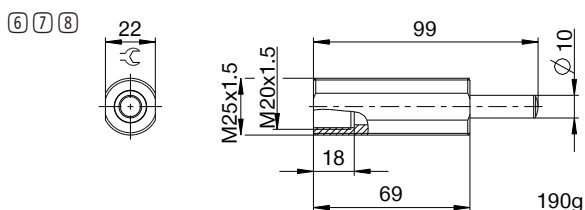
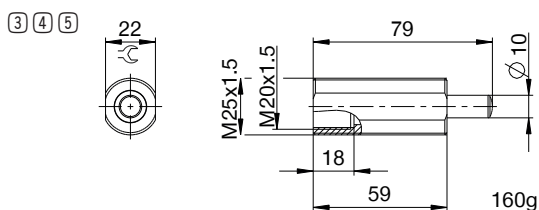
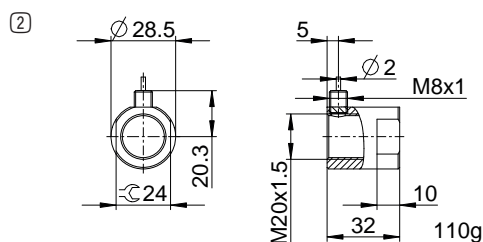
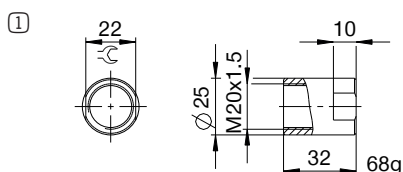



## ▶ CLASSIFICATION

P HE 20X15 L H A K -A

### Design

**P** Industrial shock absorbers PowerStop

### Series

**ME** Mini Energy

**SE** Standard Energy

**HE** High Energy

**AE** Adjustable Energy

### Thread

**20** Thread nominal diameter

**X**

**15** Thread pitch (factor 10)

### Stroke variant

**N** Standard stroke

**L** Long stroke

### Hardness degree

**H** Hard (0.1 - 1.2 m/s; Adjustable Energy: 0.1 - 5 m/s)

**M** Medium (0.8 - 2.2 m/s)

**S** Soft (1.8 - 3.5 m/s)

**W** Supersoft (3 - 5 m/s)

### Protection

**D** no protection

**F** Felt ring

**A** Wiper (NBR)

**B** Bellow (TPE)

### Head

**D** Short piston rod no head

**E** Long piston rod no head

**S** with steel head

**K** with plastic head

### Version

**-A** Versioning from a to z

# INDUSTRIAL SHOCK ABSORBERS POWERSTOP

## THREAD M22X1.5

### ► SERIES

PowerStop®



► <b>Material</b>	Stainless steel	► <b>Organic oil (biodegradable)</b>	HEES
► <b>Permitted temperature range</b>	-10 ... +70 [°C]	- <b>H1-certified</b>	Yes
► <b>Angle of Impact max.</b>	2 [°]	- <b>PWIS-free</b>	Yes
► <b>Max. force at fixed stop</b>	10 [kN]	► <b>RoHS compliant</b> - <b>REACH compliant</b>	Yes
► <b>Lock nut tightening torque</b>		► <b>Max. absolute pressure</b>	
- <b>Standard energy</b>	20 [Nm]	- <b>Standard energy</b>	1 [bar]
- <b>High Energy</b>	40 [Nm]	- <b>High Energy</b>	10 [bar]
- <b>Adjustable Energy</b>	40 [Nm]	- <b>Adjustable Energy</b>	10 [bar]

### ► TECHNICAL DATA

	Design	Series	Thread	Stroke variant	Stroke max. [mm]	Hardness degree	Impact velocity		Energy absorption max.			Protection	Reset			Head Integrated Fix stop	Version	
							min.	max.	Continuous operation		Emergency stop operation		Force min. [N]	Time max. [s]				
									per stroke [J]	per hour [J/h]					per stroke [J]			
STANDARD ENERGY	P	SE	22X15	N	15	H	0,1	1,2	41	90.000	41	D	7	15	0,3	D	x	
							M	0,8	2,2	41	90.000	41	-	-	-	E	-	
							S	1,8	3,5	41	90.000	41	F	7	15	0,3	S	x
							W	3,0	5,0	41	90.000	41	A	7	15	0,3	K	x
HIGH ENERGY	P	HE	22X15	N	15	H	0,1	1,2	80	90.000	150	D	16	26	0,3	D	x	
							M	0,8	2,2	75	90.000	125	-	-	-	E	-	
							S	1,8	3,5	70	90.000	100	F	16	26	0,3	S	x
							W	3,0	5,0	65	90.000	75	A	16	26	0,3	K	x
ADJUSTABLE ENERGY	P	AE	22X15	N	15	H	0,1	5,0	80	90.000	80	D	16	26	0,3	D	x	
							M	0,8	2,2	75	90.000	125	-	-	-	E	-	
							S	1,8	3,5	70	90.000	100	F	16	26	0,3	S	x
							W	3,0	5,0	65	90.000	75	A	16	26	0,3	K	x
HIGH ENERGY	P	HE	22X15	L	25	H	0,1	1,2	80	90.000	150	D	16	26	0,5	D	x	
							M	0,8	2,2	75	90.000	125	-	-	-	E	-	
							S	1,8	3,5	70	90.000	100	A	16	26	0,5	S	x
							W	3,0	5,0	65	90.000	75	F	16	26	0,5	K	x
ADJUSTABLE ENERGY	P	AE	22X15	L	25	H	0,1	5,0	80	90.000	80	D	16	26	0,5	D	x	
							M	0,8	2,2	75	90.000	125	-	-	-	E	-	
							S	1,8	3,5	70	90.000	100	F	16	26	0,5	S	x
							W	3,0	5,0	65	90.000	75	A	16	26	0,5	K	x

## PROTECTION

no protection	Felt ring	Wiper (NBR)
D -A	F -A	A -A
in a clean environment	against dust, chips, ...	against liquid, oil, ...

## TECHNICAL DRAWINGS

	Short piston rod no head	Long piston rod no head	with steel head	with plastic head
	N D -A	N E -A	N S -A	N K -A
STANDARD ENERGY				
HIGH ENERGY				
ADJUSTABLE ENERGY				

	Short piston rod no head	Long piston rod no head	with steel head	with plastic head
	L D -A	L E -A	L S -A	L K -A
HIGH ENERGY				
ADJUSTABLE ENERGY				



# INDUSTRIAL SHOCK ABSORBERS POWERSTOP

## THREAD M22X1.5

### ACCESSORIES

Pos.	Order no.	Accessories	Remarks
①	PAH22X15-A	Stop sleeve	Including 1x PVM22X15-A. Industrial shock absorber with bellow excluded.
②	PBV22X15ND-A	Side load adapter standard stroke Protection: no protection	Impact angle max. 30°. Can only be used in combination with industrial shock absorber without protection and without the Short piston rod no head variant. Lock nut PVM27X15-A suitable for external thread of the side load adapter.
③	PBV22X15NF-A	Side load adapter standard stroke Protection: felt ring (felt)	Impact angle max. 30°. Can only be used in combination with industrial shock absorber without protection and without the Short piston rod no head variant. Lock nut PVM27X15-A suitable for external thread of the side load adapter.
④	PBV22X15NA-A	Side load adapter standard stroke Protection: wiper (NBR)	Impact angle max. 30°. Can only be used in combination with industrial shock absorber without protection and without the Short piston rod no head variant. Lock nut PVM27X15-A suitable for external thread of the side load adapter.
⑤	PBV22X15LD-A	Side load adapter long stroke Protection: no protection	Impact angle max. 30°. Can only be used in combination with industrial shock absorber without protection and without the Short piston rod no head variant. Lock nut PVM27X15-A suitable for external thread of the side load adapter.
⑥	PBV22X15LF-A	Side load adapter long stroke Protection: felt ring (felt)	Impact angle max. 30°. Can only be used in combination with industrial shock absorber without protection and without the Short piston rod no head variant. Lock nut PVM27X15-A suitable for external thread of the side load adapter.
⑦	PBV22X15LA-A	Side load adapter long stroke Protection: wiper (NBR)	Impact angle max. 30°. Can only be used in combination with industrial shock absorber without protection and without the Short piston rod no head variant. Lock nut PVM27X15-A suitable for external thread of the side load adapter.
⑧	PKS22X15-A	Clamping flange orthogonal screwed	Tightening torque of the screws max. 10 Nm.
⑨	PKP22X15-A	Clamping flange screwed in parallel	Tightening torque of the screws max. 5 Nm.
⑩	PVM22X15-A	Stainless steel locknut	Included with the industrial shock absorber.
⑪	PDD22X15-A	Pressure chamber seal	On request. Recommended fixing with PVM22x15-A. Seal must be in full contact on both sides.

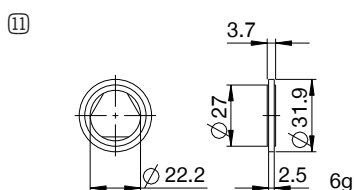
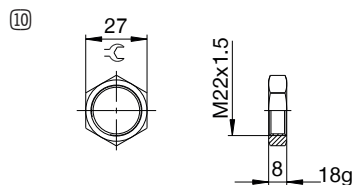
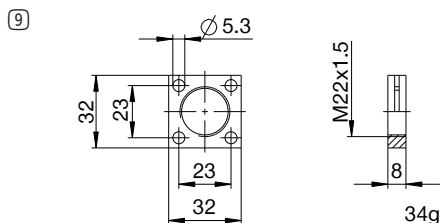
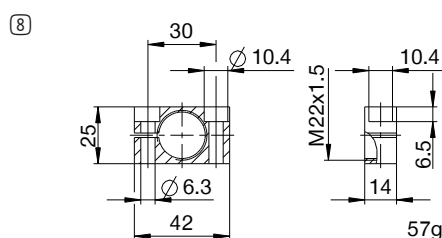
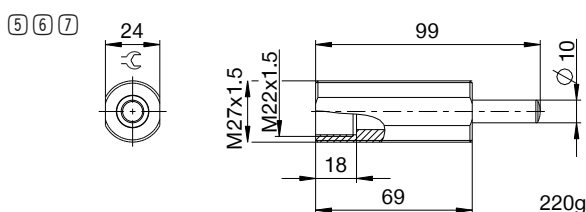
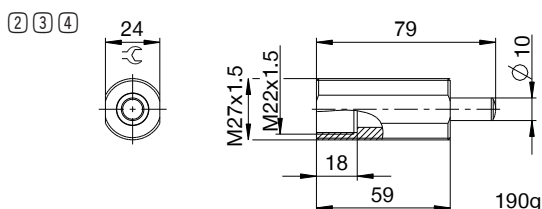
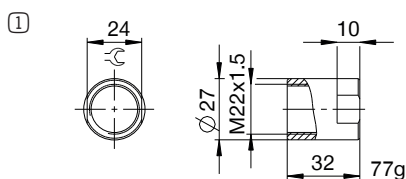

## ▶ CLASSIFICATION

P HE 22X15 L H A K -A

### Design

**P** Industrial shock absorbers PowerStop

### Series

**ME** Mini Energy

**SE** Standard Energy

**HE** High Energy

**AE** Adjustable Energy

### Thread

**22** Thread nominal diameter

**X**

**15** Thread pitch (factor 10)

### Stroke variant

**N** Standard stroke

**L** Long stroke

### Hardness degree

**H** Hard (0.1 - 1.2 m/s; Adjustable Energy: 0.1 - 5 m/s)

**M** Medium (0.8 - 2.2 m/s)

**S** Soft (1.8 - 3.5 m/s)

**W** Supersoft (3 - 5 m/s)

### Protection

**D** no protection

**F** Felt ring

**A** Wiper (NBR)

**B** Bellow (TPE)

### Head

**D** Short piston rod no head

**E** Long piston rod no head

**S** with steel head

**K** with plastic head

### Version

**-A** Versioning from a to z

# INDUSTRIAL SHOCK ABSORBERS POWERSTOP

## THREAD M25X1.5

### ► SERIES

PowerStop®



► <b>Material</b>	Stainless steel	► <b>Organic oil (biodegradable)</b>	HEES
► <b>Permitted temperature range</b>	-10 ... +70 [°C]	- <b>H1-certified</b>	Yes
► <b>Angle of Impact max.</b>	2 [°]	- <b>PWIS-free</b>	Yes
► <b>Max. force at fixed stop</b>	17 [kN]	► <b>RoHS compliant</b> - <b>REACH compliant</b>	Yes
► <b>Lock nut tightening torque</b>		► <b>Max. absolute pressure</b>	
- <b>Standard energy</b>	30 [Nm]	- <b>Standard energy</b>	1 [bar]
- <b>High Energy</b>	60 [Nm]	- <b>High Energy</b>	10 [bar]
- <b>Adjustable Energy</b>	60 [Nm]	- <b>Adjustable Energy</b>	10 [bar]

### ► TECHNICAL DATA

	Design	Series	Thread	Stroke variant	Stroke max. [mm]	Hardness degree	Impact velocity		Energy absorption max.			Protection	Reset			Head	Integrated Fix stop	Version	
							min.	max.	Continuous operation		Emergency stop operation		Force min. [N]	Time max. [s]					
									per stroke [J]	per hour [J/h]					per stroke [J]				
STANDARD ENERGY	P	SE	25X15	N	25	H	0,1	1,2	105	120.000	105	D	11	26	0,4	D	x	-A	
							M	0,8	2,2	105	120.000	105	F	11	26	0,4	E		-
							S	1,8	3,5	105	120.000	105	A	11	26	0,4	S		x
							W	3,0	5,0	105	120.000	105	B	11	95	0,4	K		x
HIGH ENERGY	P	HE	25X15	N	25	H	0,1	1,2	230	120.000	400	D	26	45	0,4	D	x	-A	
							M	0,8	2,2	210	120.000	330	F	26	45	0,4	E		-
							S	1,8	3,5	190	120.000	260	A	26	45	0,4	S		x
							W	3,0	5,0	170	120.000	190	B	26	115	0,4	K		x
ADJUSTABLE ENERGY	P	AE	25X15	N	25	H	0,1	5,0	230	120.000	230	D	26	45	0,4	D	x	-A	
							M	0,8	2,2	210	120.000	330	F	26	45	0,4	E		-
							S	1,8	3,5	190	120.000	260	A	26	45	0,4	S		x
							W	3,0	5,0	170	120.000	190	B	26	115	0,4	K		x
HIGH ENERGY	P	HE	25X15	L	40	H	0,1	1,2	230	120.000	400	D	26	45	0,6	D	x	-A	
							M	0,8	2,2	210	120.000	330	F	26	45	0,6	E		-
							S	1,8	3,5	190	120.000	260	A	26	45	0,6	S		x
							W	3,0	5,0	170	120.000	190	B	26	45	0,6	K		x
ADJUSTABLE ENERGY	P	AE	25X15	L	40	H	0,1	5,0	230	120.000	230	D	26	45	0,6	D	x	-A	
							M	0,8	2,2	210	120.000	330	F	26	45	0,6	E		-
							S	1,8	3,5	190	120.000	260	A	26	45	0,6	S		x
							W	3,0	5,0	170	120.000	190	B	26	45	0,6	K		x

## PROTECTION

no protection	Felt ring	Wiper (NBR)	Bellow (TPE)
D -A	F -A	A -A	B -A
in a clean environment	against dust, chips, ...	against liquid, oil, ...	

## TECHNICAL DRAWINGS

	Short piston rod no head	Long piston rod no head	with steel head	with plastic head	with bellow and steel head	with bellow and plastic head
	N D -A	N E -A	N S -A	N K -A	N B S -A	N B K -A
STANDARD ENERGY						
HIGH ENERGY						
ADJUSTABLE ENERGY						

	Short piston rod no head	Long piston rod no head	with steel head	with plastic head
	L D -A	L E -A	L S -A	L K -A
HIGH ENERGY				
ADJUSTABLE ENERGY				



# INDUSTRIAL SHOCK ABSORBERS POWERSTOP

## THREAD M25X1.5

### ACCESSORIES

Pos.	Order no.	Accessories	Remarks
①	PAH25X15-A	Stop sleeve	Including 1x PVM25X15-A. Industrial shock absorber with bellow excluded.
②	PSH25X15-B	Sensor stop sleeve	Including 1x PVM25X15-A. Sensing only possible via industrial shock absorbers with steel or plastic head. Industrial shock absorber with bellow excluded. Inductive sensor, PNP (NC), 2 m PUR cable, IP67 degree of protection. See separate data sheet for additional information.
③	PBV25X15ND-A	Side load adapter standard stroke Protection: no protection	Impact angle max. 30°. Can only be used in combination with industrial shock absorber without protection and without the Short piston rod no head variant. Lock nut PVM33X15-A suitable for external thread of the side load adapter.
④	PBV25X15NF-A	Side load adapter standard stroke Protection: felt ring (felt)	Impact angle max. 30°. Can only be used in combination with industrial shock absorber without protection and without the Short piston rod no head variant. Lock nut PVM33X15-A suitable for external thread of the side load adapter.
⑤	PBV25X15NA-A	Side load adapter standard stroke Protection: wiper (NBR)	Impact angle max. 30°. Can only be used in combination with industrial shock absorber without protection and without the Short piston rod no head variant. Lock nut PVM33X15-A suitable for external thread of the side load adapter.
⑥	PBV25X15LD-A	Side load adapter long stroke Protection: no protection	Impact angle max. 30°. Can only be used in combination with industrial shock absorber without protection and without the Short piston rod no head variant. Lock nut PVM33X15-A suitable for external thread of the side load adapter.
⑦	PBV25X15LF-A	Side load adapter long stroke Protection: felt ring (felt)	Impact angle max. 30°. Can only be used in combination with industrial shock absorber without protection and without the Short piston rod no head variant. Lock nut PVM33X15-A suitable for external thread of the side load adapter.
⑧	PBV25X15LA-A	Side load adapter long stroke Protection: wiper (NBR)	Impact angle max. 30°. Can only be used in combination with industrial shock absorber without protection and without the Short piston rod no head variant. Lock nut PVM33X15-A suitable for external thread of the side load adapter.
⑨	PKS25X15-A	Clamping flange orthogonal screwed	Tightening torque of the screws max. 22 Nm.
⑩	PKP25X15-A	Clamping flange screwed in parallel	Tightening torque of the screws max. 10 Nm.
⑪	PVM25X15-A	Stainless steel locknut	Included with the industrial shock absorber.
⑫	PDD25X15-A	Pressure chamber seal	Recommended fixation with PVM25X15-A. Seal must be in full contact on both sides.

①

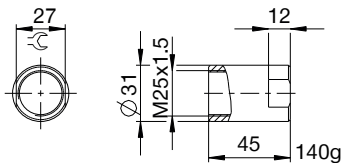

②

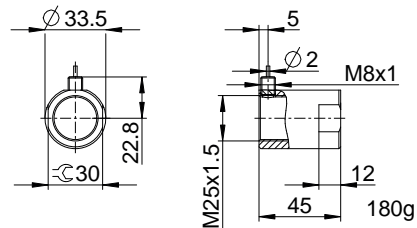

③ ④ ⑤

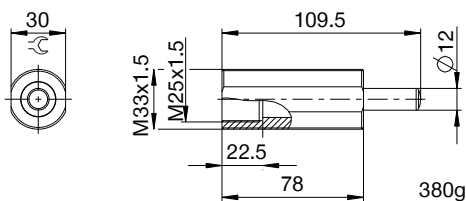

⑥ ⑦ ⑧

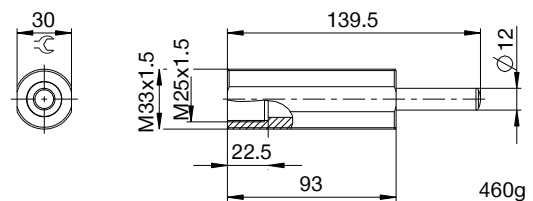

⑨

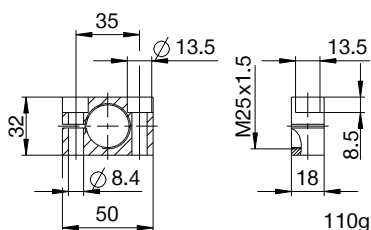

⑩

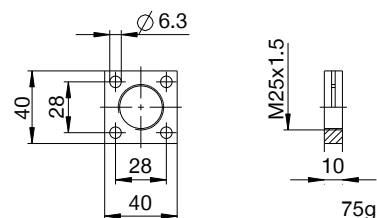

⑪

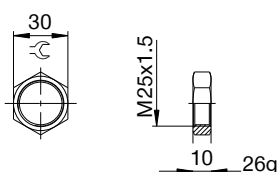

⑫

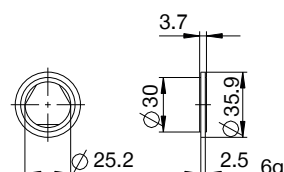



## ▶ CLASSIFICATION

P HE 25X15 L H A K -A

### Design

**P** Industrial shock absorbers PowerStop

### Series

**ME** Mini Energy

**SE** Standard Energy

**HE** High Energy

**AE** Adjustable Energy

### Thread

**25** Thread nominal diameter

**X**

**15** Thread pitch (factor 10)

### Stroke variant

**N** Standard stroke

**L** Long stroke

### Hardness degree

**H** Hard (0.1 - 1.2 m/s; Adjustable Energy: 0.1 - 5 m/s)

**M** Medium (0.8 - 2.2 m/s)

**S** Soft (1.8 - 3.5 m/s)

**W** Supersoft (3 - 5 m/s)

### Protection

**D** no protection

**F** Felt ring

**A** Wiper (NBR)

**B** Bellow (TPE)

### Head

**D** Short piston rod no head

**E** Long piston rod no head

**S** with steel head

**K** with plastic head

### Version

**-A** Versioning from a to z

# INDUSTRIAL SHOCK ABSORBERS POWERSTOP

## THREAD M27X1.5

### ► SERIES

PowerStop®



► <b>Material</b>	Stainless steel	► <b>Organic oil (biodegradable)</b>	HEES
► <b>Permitted temperature range</b>	-10 ... +70 [°C]	- <b>H1-certified</b>	Yes
► <b>Angle of Impact max.</b>	2 [°]	- <b>PWIS-free</b>	Yes
► <b>Max. force at fixed stop</b>	17 [kN]	► <b>RoHS compliant</b> - <b>REACH compliant</b>	Yes
► <b>Lock nut tightening torque</b>		► <b>Max. absolute pressure</b>	
- <b>Standard energy</b>	30 [Nm]	- <b>Standard energy</b>	1 [bar]
- <b>High Energy</b>	60 [Nm]	- <b>High Energy</b>	10 [bar]
- <b>Adjustable Energy</b>	60 [Nm]	- <b>Adjustable Energy</b>	10 [bar]

### ► TECHNICAL DATA

	Design	Series	Thread	Stroke variant	Stroke max. [mm]	Hardness degree	Impact velocity		Energy absorption max.			Protection	Release			Head	Integrated Fix stop	Version	
							min.	max.	Continuous operation		Emergency stop operation		min.	max.	Time				
									per stroke	per hour									per stroke
					[m/s]	[m/s]	[J]	[J/h]	[J]	[N]	[N]	[s]							
STANDARD ENERGY	P	SE	27X15	N	25	H	0,1	1,2	105	120.000	105	D	11	26	0,4	D	x	-A	
							M	0,8	2,2	105	120.000	105	-	-	-	-	E		-
							S	1,8	3,5	105	120.000	105	F	11	26	0,4	S		x
							W	3,0	5,0	105	120.000	105	A	11	26	0,4	K		x
HIGH ENERGY	P	HE	27X15	N	25	H	0,1	1,2	230	120.000	400	D	26	45	0,4	D	x	-A	
							M	0,8	2,2	210	120.000	330	-	-	-	-	E		-
							S	1,8	3,5	190	120.000	260	F	26	45	0,4	S		x
							W	3,0	5,0	170	120.000	190	A	26	45	0,4	K		x
ADJUSTABLE ENERGY	P	AE	27X15	N	25	H	0,1	5,0	230	120.000	230	D	26	45	0,4	D	x	-A	
							F	26	45	0,4	-	-	-	-	E	-			
							A	26	45	0,4	-	-	-	-	S	x			
HIGH ENERGY	P	HE	27X15	L	40	H	0,1	1,2	230	120.000	400	D	26	45	0,6	D	x	-A	
							M	0,8	2,2	210	120.000	330	-	-	-	-	E		-
							S	1,8	3,5	190	120.000	260	F	26	45	0,6	S		x
							W	3,0	5,0	170	120.000	190	A	26	45	0,6	K		x
ADJUSTABLE ENERGY	P	AE	27X15	L	40	H	0,1	5,0	230	120.000	230	D	26	45	0,6	D	x	-A	
							F	26	45	0,6	-	-	-	-	E	-			
							A	26	45	0,6	-	-	-	-	S	x			

## PROTECTION

no protection	Felt ring	Wiper (NBR)
D -A	F -A	A -A
in a clean environment	against dust, chips, ...	against liquid, oil, ...

## TECHNICAL DRAWINGS – STANDARD STROKE

N -A

	Short piston rod no head	Long piston rod no head	with steel head	with plastic head
	N   D -A	N   E -A	N   S -A	N   K -A
STANDARD ENERGY	 132, 19, 32, 8, 4, 10, 25, 107, 330g	 140, 25, 8, 107, 33g, 330g	 145, 25, 17, 23, 13, 107, 370g	 145, 25, 17, 23, 13, 107, 370g
HIGH ENERGY	 132, 19, 32, 8, 4, 10, 25, 107, 340g	 140, 25, 8, 107, 340g	 145, 25, 17, 23, 13, 107, 380g	 145, 25, 17, 23, 13, 107, 380g
ADJUSTABLE ENERGY	 145, 18.6, 2.5, 19, 32, 8, 4, 10, 25, 13, 107, 360g	 153, 25, 8, 107, 360g	 158, 25, 17, 23, 13, 107, 400g	 158, 25, 17, 23, 13, 107, 400g

	Short piston rod no head	Long piston rod no head	with steel head	with plastic head
	L   D -A	L   E -A	L   S -A	L   K -A
HIGH ENERGY	 182, 19, 32, 8, 4, 10, 40, 142, 450g	 190, 40, 8, 142, 48, 450g	 195, 40, 17, 23, 13, 142, 490g	 195, 40, 17, 23, 13, 142, 490g
ADJUSTABLE ENERGY	 195, 18.6, 2.5, 19, 32, 8, 4, 10, 40, 13, 142, 470g	 203, 40, 8, 142, 48, 470g	 208, 40, 17, 23, 13, 142, 510g	 208, 40, 17, 23, 13, 142, 510g



# INDUSTRIAL SHOCK ABSORBERS POWERSTOP

## THREAD M27X1.5

### ACCESSORIES

Pos.	Order no.	Accessories	Remarks
①	<b>PAH27X15-A</b>	Stop sleeve	Including 1x PVM27X15-A. Industrial shock absorber with bellow excluded.
②	<b>PBV27X15ND-A</b>	Side load adapter standard stroke Protection: no protection	Impact angle max. 30°. Can only be used in combination with industrial shock absorber without protection and without the Short piston rod no head variant. Lock nut PVM36X15-A suitable for external thread of the side load adapter.
③	<b>PBV27X15NF-A</b>	Side load adapter standard stroke Protection: felt ring (felt)	Impact angle max. 30°. Can only be used in combination with industrial shock absorber without protection and without the Short piston rod no head variant. Lock nut PVM36X15-A suitable for external thread of the side load adapter.
④	<b>PBV27X15NA-A</b>	Side load adapter standard stroke Protection: wiper (NBR)	Impact angle max. 30°. Can only be used in combination with industrial shock absorber without protection and without the Short piston rod no head variant. Lock nut PVM36X15-A suitable for external thread of the side load adapter.
⑤	<b>PBV27X15LD-A</b>	Side load adapter long stroke Protection: no protection	Impact angle max. 30°. Can only be used in combination with industrial shock absorber without protection and without the Short piston rod no head variant. Lock nut PVM36X15-A suitable for external thread of the side load adapter.
⑥	<b>PBV27X15LF-A</b>	Side load adapter long stroke Protection: felt ring (felt)	Impact angle max. 30°. Can only be used in combination with industrial shock absorber without protection and without the Short piston rod no head variant. Lock nut PVM36X15-A suitable for external thread of the side load adapter.
⑦	<b>PBV27X15LA-A</b>	Side load adapter long stroke Protection: wiper (NBR)	Impact angle max. 30°. Can only be used in combination with industrial shock absorber without protection and without the Short piston rod no head variant. Lock nut PVM36X15-A suitable for external thread of the side load adapter.
⑧	<b>PKS27X15-A</b>	Clamping flange orthogonal screwed	Tightening torque of the screws max. 22 Nm.
⑨	<b>PKP27X15-A</b>	Clamping flange screwed in parallel	Tightening torque of the screws max. 10 Nm.
⑩	<b>PVM27X15-A</b>	Stainless steel locknut	Included with the industrial shock absorber.
⑪	<b>PDD27X15-A</b>	Pressure chamber seal	On request. Recommended fixing with PVM27x15-A. Seal must be in full contact on both sides.

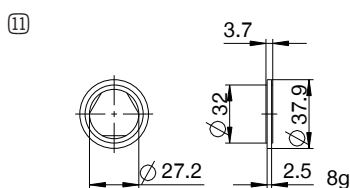
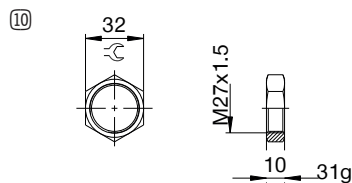
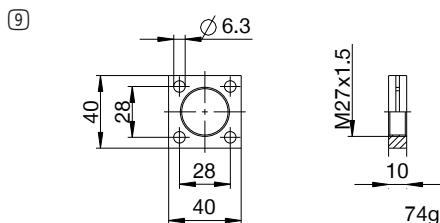
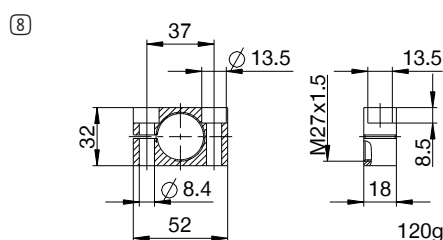
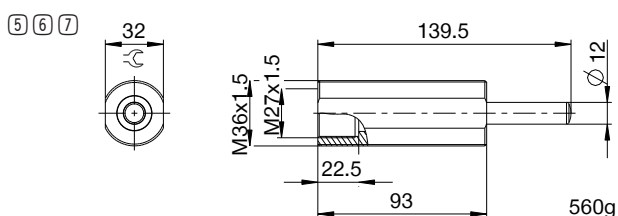
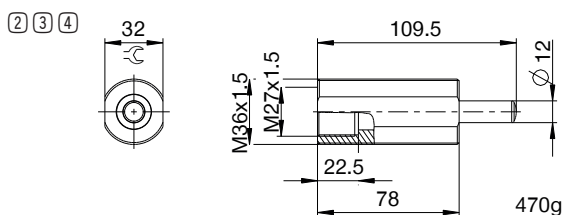
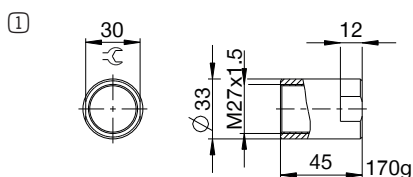

## ▶ CLASSIFICATION

P HE 27X15 L H A K -A

### Design

**P** Industrial shock absorbers PowerStop

### Series

**ME** Mini Energy

**SE** Standard Energy

**HE** High Energy

**AE** Adjustable Energy

### Thread

**27** Thread nominal diameter

**X**

**15** Thread pitch (factor 10)

### Stroke variant

**N** Standard stroke

**L** Long stroke

### Hardness degree

**H** Hard (0.1 - 1.2 m/s; Adjustable Energy: 0.1 - 5 m/s)

**M** Medium (0.8 - 2.2 m/s)

**S** Soft (1.8 - 3.5 m/s)

**W** Supersoft (3 - 5 m/s)

### Protection

**D** no protection

**F** Felt ring

**A** Wiper (NBR)

**B** Bellow (TPE)

### Head

**D** Short piston rod no head

**E** Long piston rod no head

**S** with steel head

**K** with plastic head

### Version

**-A** Versioning from a to z

# INDUSTRIAL SHOCK ABSORBERS POWERSTOP THREAD M27X3

## ► SERIES

PowerStop®



► <b>Material</b>	Stainless steel	► <b>Organic oil (biodegradable)</b>	HEES
► <b>Permitted temperature range</b>	-10 ... +70 [°C]	- <b>H1-certified</b>	Yes
► <b>Angle of Impact max.</b>	2 [°]	- <b>PWIS-free</b>	Yes
► <b>Max. force at fixed stop</b>	17 [kN]	► <b>RoHS compliant</b> - <b>REACH compliant</b>	Yes
► <b>Lock nut tightening torque</b>		► <b>Max. absolute pressure</b>	
- <b>Standard energy</b>	30 [Nm]	- <b>Standard energy</b>	1 [bar]
- <b>High Energy</b>	60 [Nm]	- <b>High Energy</b>	10 [bar]
- <b>Adjustable Energy</b>	60 [Nm]	- <b>Adjustable Energy</b>	10 [bar]

## ► TECHNICAL DATA

	Design	Series	Thread	Stroke variant	Stroke max. [mm]	Hardness degree	Impact velocity		Energy absorption max.			Protection	Reset			Head Integrated stop	Version		
							min. [m/s]	max. [m/s]	Continuous operation		Emergency stop operation per stroke [J]		Force		Time max. [s]				
									per stroke [J]	per hour [J/h]			min. [N]	max. [N]					
STANDARD ENERGY	P	SE	27X30	N	25	H	0,1	1,2	105	120.000	105	D	11	26	0,4	D	x		
							M	0,8	2,2	105	120.000	105	-	-	-	-	E	-	
								S	1,8	3,5	105	120.000	105	F	11	26	0,4	S	x
									W	3,0	5,0	105	120.000	105	A	11	26	0,4	K
HIGH ENERGY	P	HE	27X30	N	25	H	0,1	1,2	230	120.000	400	D	26	45	0,4	D	x		
							M	0,8	2,2	210	120.000	330	-	-	-	-	E	-	
								S	1,8	3,5	190	120.000	260	F	26	45	0,4	S	x
									W	3,0	5,0	170	120.000	190	A	26	45	0,4	K
ADJUSTABLE ENERGY	P	AE	27X30	N	25	H	0,1	5,0	230	120.000	230	D	26	45	0,4	D	x		
							M	0,8	5,0	210	120.000	230	-	-	-	-	E	-	
								S	1,8	5,0	190	120.000	260	F	26	45	0,4	S	x
									W	3,0	5,0	170	120.000	190	A	26	45	0,4	K
HIGH ENERGY	P	HE	27X30	L	40	H	0,1	1,2	230	120.000	400	D	26	45	0,6	D	x		
							M	0,8	2,2	210	120.000	330	-	-	-	-	E	-	
								S	1,8	3,5	190	120.000	260	F	26	45	0,6	S	x
									W	3,0	5,0	170	120.000	190	A	26	45	0,6	K
ADJUSTABLE ENERGY	P	AE	27X30	L	40	H	0,1	5,0	230	120.000	230	D	26	45	0,6	D	x		
							M	0,8	5,0	210	120.000	230	-	-	-	-	E	-	
								S	1,8	5,0	190	120.000	260	F	26	45	0,6	S	x
									W	3,0	5,0	170	120.000	190	A	26	45	0,6	K

## PROTECTION

no protection	Felt ring	Wiper (NBR)
D -A	F -A	A -A
in a clean environment	against dust, chips, ...	against liquid, oil, ...

## TECHNICAL DRAWINGS

	Short piston rod no head	Long piston rod no head	with steel head	with plastic head
	N D -A	N E -A	N S -A	N K -A
STANDARD ENERGY				
HIGH ENERGY				
ADJUSTABLE ENERGY				

	Short piston rod no head	Long piston rod no head	with steel head	with plastic head
	L D -A	L E -A	L S -A	L K -A
HIGH ENERGY				
ADJUSTABLE ENERGY				



# INDUSTRIAL SHOCK ABSORBERS POWERSTOP THREAD M27X3

## ▶ ACCESSORIES

Pos.	Order no.	Accessories	Remarks
①	PAH27X30-A	Stop sleeve	Including 1x PVM27X30-A. Industrial shock absorber with bellow excluded.
②	PBV27X30ND-A	Side load adapter standard stroke Protection: no protection	Impact angle max. 30°. Can only be used in combination with industrial shock absorber without protection and without the Short piston rod no head variant. Lock nut PVM36X15-A suitable for external thread of the side load adapter.
③	PBV27X30NF-A	Side load adapter standard stroke Protection: felt ring (felt)	Impact angle max. 30°. Can only be used in combination with industrial shock absorber without protection and without the Short piston rod no head variant. Lock nut PVM36X15-A suitable for external thread of the side load adapter.
④	PBV27X30NA-A	Side load adapter standard stroke Protection: wiper (NBR)	Impact angle max. 30°. Can only be used in combination with industrial shock absorber without protection and without the Short piston rod no head variant. Lock nut PVM36X15-A suitable for external thread of the side load adapter.
⑤	PBV27X30LD-A	Side load adapter long stroke Protection: no protection	Impact angle max. 30°. Can only be used in combination with industrial shock absorber without protection and without the Short piston rod no head variant. Lock nut PVM36X15-A suitable for external thread of the side load adapter.
⑥	PBV27X30LF-A	Side load adapter long stroke Protection: felt ring (felt)	Impact angle max. 30°. Can only be used in combination with industrial shock absorber without protection and without the Short piston rod no head variant. Lock nut PVM36X15-A suitable for external thread of the side load adapter.
⑦	PBV27X30LA-A	Side load adapter long stroke Protection: wiper (NBR)	Impact angle max. 30°. Can only be used in combination with industrial shock absorber without protection and without the Short piston rod no head variant. Lock nut PVM36X15-A suitable for external thread of the side load adapter.
⑧	PKS27X30-A	Clamping flange orthogonal screwed	Tightening torque of the screws max. 22 Nm.
⑨	PKP27X30-A	Clamping flange screwed in parallel	Tightening torque of the screws max. 10 Nm.
⑩	PVM27X30-A	Stainless steel locknut	Included with the industrial shock absorber.
⑪	PDD27X30-A	Pressure chamber seal	On request. Recommended fixing with PVM27X30-A. Seal must be in full contact on both sides.

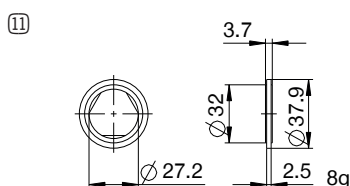
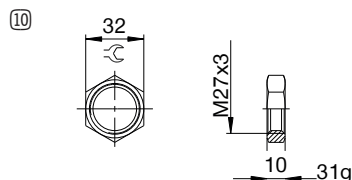
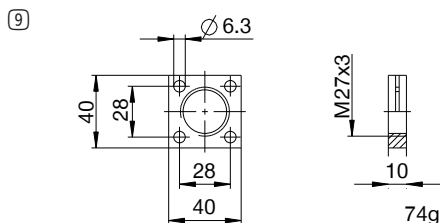
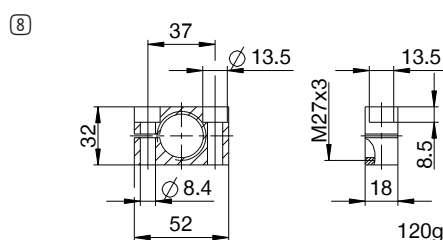
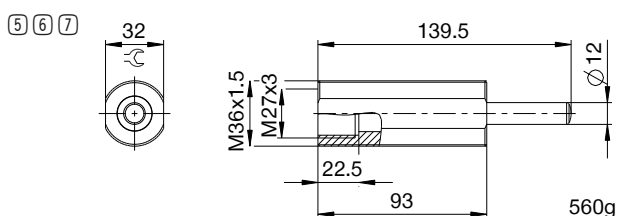
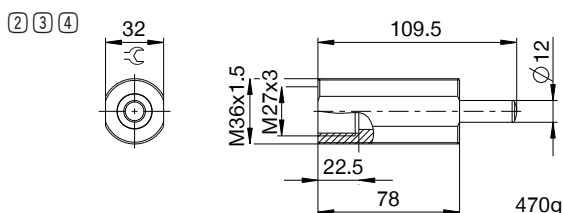
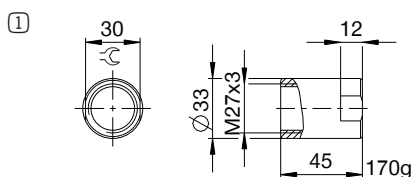



## ▶ CLASSIFICATION

P HE 27X3 L H A K -A

### Design

**P** Industrial shock absorbers PowerStop

### Series

**ME** Mini Energy

**SE** Standard Energy

**HE** High Energy

**AE** Adjustable Energy

### Thread

**27** Thread nominal diameter

**X**

**30** Thread pitch (factor 10)

### Stroke variant

**N** Standard stroke

**L** Long stroke

### Hardness degree

**H** Hard (0.1 - 1.2 m/s; Adjustable Energy: 0.1 - 5 m/s)

**M** Medium (0.8 - 2.2 m/s)

**S** Soft (1.8 - 3.5 m/s)

**W** Supersoft (3 - 5 m/s)

### Protection

**D** no protection

**F** Felt ring

**A** Wiper (NBR)

**B** Bellow (TPE)

### Head

**D** Short piston rod no head

**E** Long piston rod no head

**S** with steel head

**K** with plastic head

### Version

**-A** Versioning from a to z

# INDUSTRIAL SHOCK ABSORBERS POWERSTOP THREAD M33X1.5

## ► SERIES

PowerStop®



► <b>Material</b>	Stainless steel	► <b>Organic oil (biodegradable)</b>	HEES
► <b>Permitted temperature range</b>	-10 ... +70 [°C]	- <b>H1-certified</b>	Yes
► <b>Angle of Impact max.</b>	2 [°]	- <b>PWIS-free</b>	Yes
► <b>Max. force at fixed stop</b>	30 [kN]	► <b>RoHS compliant</b> - <b>REACH compliant</b>	Yes
► <b>Lock nut tightening torque</b>		► <b>Max. absolute pressure</b>	
- <b>Standard energy</b>	60 [Nm]	- <b>Standard energy</b>	1 [bar]
- <b>High Energy</b>	80 [Nm]	- <b>High Energy</b>	10 [bar]
- <b>Adjustable Energy</b>	80 [Nm]	- <b>Adjustable Energy</b>	10 [bar]

## ► TECHNICAL DATA

	Design	Series	Thread	Stroke variant	Stroke max. [mm]	Hardness degree	Impact velocity		Energy absorption max.			Protection	Reset			Head Integrated stop	Version		
							min. [m/s]	max. [m/s]	Continuous operation		Emergency stop operation per stroke [J]		Force min. [N]	Time max. [s]					
									per stroke [J]	per hour [J/h]					per stroke [J]				
STANDARD ENERGY	P	SE	33X15	N	30	H	0,1	1,2	185	140.000	185	D	15	35	0,4	D	x	-A	
							M	0,8	2,2	185	140.000	185	F	15	35	0,4	E		-
							S	1,8	3,5	185	140.000	185	A	15	35	0,4	S		x
							W	3,0	5,0	185	140.000	185	B	15	230	0,4	K		x
HIGH ENERGY	P	HE	33X15	N	30	H	0,1	1,2	400	140.000	800	D	40	65	0,4	D	x	-A	
							M	0,8	2,2	360	140.000	650	F	40	65	0,4	E		-
							S	1,8	3,5	320	140.000	500	A	40	65	0,4	S		x
							W	3,0	5,0	280	140.000	350	B	40	260	0,4	K		x
ADJUSTABLE ENERGY	P	AE	33X15	N	30	H	0,1	5,0	400	140.000	400	D	40	65	0,4	D	x	-A	
							M	0,8	2,2	360	140.000	650	F	40	65	0,4	E		-
							S	1,8	3,5	320	140.000	500	A	40	65	0,4	S		x
							W	3,0	5,0	280	140.000	350	B	40	260	0,4	K		x
HIGH ENERGY	P	HE	33X15	L	50	H	0,1	1,2	400	140.000	800	D	40	65	0,8	D	x	-A	
							M	0,8	2,2	360	140.000	650	F	40	65	0,8	E		-
							S	1,8	3,5	320	140.000	500	A	40	65	0,8	S		x
							W	3,0	5,0	280	140.000	350	A	40	65	0,8	K		x
ADJUSTABLE ENERGY	P	AE	33X15	L	50	H	0,1	5,0	400	140.000	400	D	40	65	0,8	D	x	-A	
							M	0,8	2,2	360	140.000	650	F	40	65	0,8	E		-
							S	1,8	3,5	320	140.000	500	A	40	65	0,8	S		x
							W	3,0	5,0	280	140.000	350	A	40	65	0,8	K		x

## PROTECTION

no protection	Felt ring	Wiper (NBR)	Bellow (TPE)
D -A	F -A	A -A	B -A
in a clean environment	against dust, chips, ...	against liquid, oil, ...	

## TECHNICAL DRAWINGS

	Short piston rod no head	Long piston rod no head	with steel head	with plastic head	with bellow and steel head	with bellow and plastic head
	N D -A	N E -A	N S -A	N K -A	N B S -A	N B K -A
STANDARD ENERGY	 155, 125, 570g	 165, 125, 580g	 170, 125, 640g	 170, 125, 640g	 181, 110.5, 700g	 181, 110.5, 700g
HIGH ENERGY	 156, 126, 590g	 166, 126, 600g	 171, 126, 660g	 171, 126, 660g	 182, 111.5, 720g	 182, 111.5, 720g
ADJUSTABLE ENERGY	 173, 126, 640g	 183, 126, 640g	 188, 126, 710g	 188, 126, 710g	 199, 111.5, 770g	 199, 111.5, 770g

	Short piston rod no head	Long piston rod no head	with steel head	with plastic head
	L D -A	L E -A	L S -A	L K -A
HIGH ENERGY	 221, 171, 790g	 231, 171, 800g	 236, 171, 860g	 236, 171, 860g
ADJUSTABLE ENERGY	 238, 171, 850g	 248, 171, 860g	 253, 171, 920g	 253, 171, 920g



# INDUSTRIAL SHOCK ABSORBERS POWERSTOP

## THREAD M33X1.5

### ACCESSORIES

Pos.	Order no.	Accessories	Remarks
①	PAH33X15-A	Stop sleeve	Including 1x PVM33X15-A. Industrial shock absorber with bellow excluded.
②	PSH33X15-B	Sensor stop sleeve	Including 1x PVM33X15-A. Sensing only possible via industrial shock absorbers with steel or plastic head. Industrial shock absorber with bellow excluded. Inductive sensor, PNP (NC), 2 m PUR cable, IP67 degree of protection. See separate data sheet for additional information.
③	PBV33X15ND-A	Side load adapter standard stroke Protection: no protection	Impact angle max. 30°. Can only be used in combination with industrial shock absorber without protection and without the Short piston rod no head variant. Lock nut PVM42X15-A suitable for external thread of the side load adapter.
④	PBV33X15NF-A	Side load adapter standard stroke Protection: felt ring (felt)	Impact angle max. 30°. Can only be used in combination with industrial shock absorber without protection and without the Short piston rod no head variant. Lock nut PVM42X15-A suitable for external thread of the side load adapter.
⑤	PBV33X15NA-A	Side load adapter standard stroke Protection: wiper (NBR)	Impact angle max. 30°. Can only be used in combination with industrial shock absorber without protection and without the Short piston rod no head variant. Lock nut PVM42X15-A suitable for external thread of the side load adapter.
⑥	PBV33X15LD-A	Side load adapter long stroke Protection: no protection	Impact angle max. 30°. Can only be used in combination with industrial shock absorber without protection and without the Short piston rod no head variant. Lock nut PVM42X15-A suitable for external thread of the side load adapter.
⑦	PBV33X15LF-A	Side load adapter long stroke Protection: felt ring (felt)	Impact angle max. 30°. Can only be used in combination with industrial shock absorber without protection and without the Short piston rod no head variant. Lock nut PVM42X15-A suitable for external thread of the side load adapter.
⑧	PBV33X15LA-A	Side load adapter long stroke Protection: wiper (NBR)	Impact angle max. 30°. Can only be used in combination with industrial shock absorber without protection and without the Short piston rod no head variant. Lock nut PVM42X15-A suitable for external thread of the side load adapter.
⑨	PKS33X15-A	Clamping flange orthogonal screwed	Tightening torque of the screws max. 45 Nm.
⑩	PKP33X15-A	Clamping flange screwed in parallel	Tightening torque of the screws max. 22 Nm.
⑪	PVM33X15-A	Stainless steel locknut	Included with the industrial shock absorber.
⑫	PDD33X15-A	Pressure chamber seal	Recommended fixation with PVM33X15-A. Seal must be in full contact on both sides.

①

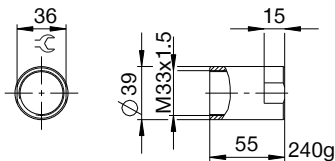

②

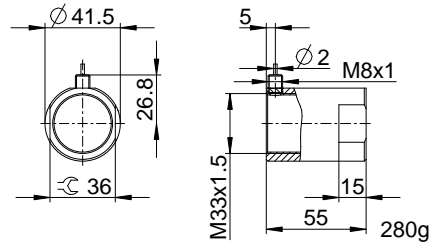

③ ④ ⑤

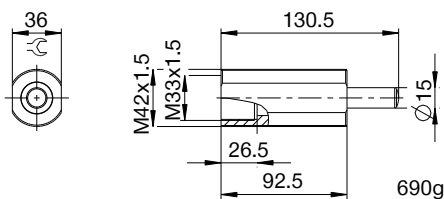

⑥ ⑦ ⑧

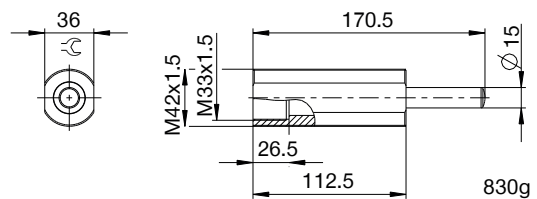

⑨

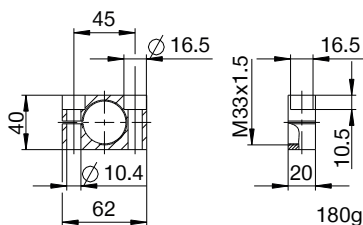

⑩

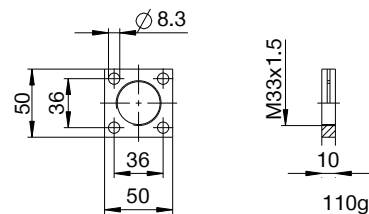

⑪

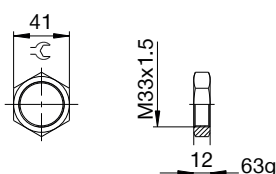

⑫

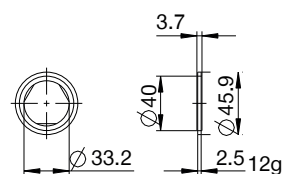

## ▶ CLASSIFICATION

P HE 33X15 L H A K -A

### Design

**P** Industrial shock absorbers PowerStop

### Series

**ME** Mini Energy

**SE** Standard Energy

**HE** High Energy

**AE** Adjustable Energy

### Thread

**33** Thread nominal diameter

**X**

**15** Thread pitch (factor 10)

### Stroke variant

**N** Standard stroke

**L** Long stroke

### Hardness degree

**H** Hard (0.1 - 1.2 m/s; Adjustable Energy: 0.1 - 5 m/s)

**M** Medium (0.8 - 2.2 m/s)

**S** Soft (1.8 - 3.5 m/s)

**W** Supersoft (3 - 5 m/s)

### Protection

**D** no protection

**F** Felt ring

**A** Wiper (NBR)

**B** Bellow (TPE)

### Head

**D** Short piston rod no head

**E** Long piston rod no head

**S** with steel head

**K** with plastic head

### Version

**-A** Versioning from a to z

# INDUSTRIAL SHOCK ABSORBERS POWERSTOP

## THREAD M36X1.5

### SERIES

PowerStop®



▶ <b>Material</b>	Stainless steel	▶ <b>Organic oil (biodegradable)</b>	HEES
▶ <b>Permitted temperature range</b>	-10 ... +70 [°C]	- <b>H1-certified</b>	Yes
▶ <b>Angle of Impact max.</b>	2 [°]	- <b>PWIS-free</b>	Yes
▶ <b>Max. force at fixed stop</b>	30 [kN]	▶ <b>RoHS compliant</b> - <b>REACH compliant</b>	Yes
▶ <b>Lock nut tightening torque</b>		▶ <b>Max. absolute pressure</b>	
- <b>Standard energy</b>	60 [Nm]	- <b>Standard energy</b>	1 [bar]
- <b>High Energy</b>	80 [Nm]	- <b>High Energy</b>	10 [bar]
- <b>Adjustable Energy</b>	80 [Nm]	- <b>Adjustable Energy</b>	10 [bar]

### TECHNICAL DATA

	Design	Series	Thread	Stroke variant	Stroke max. [mm]	Hardness degree	Impact velocity		Energy absorption max.			Protection	Reset			Head Integrated stop	Version		
							min.	max.	Continuous operation		Emergency stop operation		Force min. [N]	Time max. [s]					
									per stroke [J]	per hour [J/h]					per stroke [J]				
STANDARD ENERGY	P	SE	36X15	N	30	H	0,1	1,2	185	140.000	185	D	15	35	0,4	D	x		
							M	0,8	2,2	185	140.000	185	-	-	-	-	-	-	-
							S	1,8	3,5	185	140.000	185	F	15	35	0,4	S	x	
							W	3,0	5,0	185	140.000	185	A	15	35	0,4	K	x	
HIGH ENERGY	P	HE	36X15	N	30	H	0,1	1,2	400	120.000	800	D	40	65	0,4	D	x		
							M	0,8	2,2	360	120.000	650	-	-	-	-	-	-	
							S	1,8	3,5	320	120.000	500	F	40	65	0,4	S	x	
							W	3,0	5,0	280	120.000	350	A	40	65	0,4	K	x	
ADJUSTABLE ENERGY	P	AE	36X151	N	30	H	0,1	5,0	400	140.000	400	D	40	65	0,4	D	x		
							M	-	-	-	-	-	-	-	-	-	-	-	
							S	-	-	-	-	-	F	40	65	0,4	S	x	
							W	-	-	-	-	-	A	40	65	0,4	K	x	
HIGH ENERGY	P	HE	36X15	L	50	H	0,1	1,2	400	140.000	800	D	40	65	0,8	D	x		
							M	0,8	2,2	360	140.000	650	-	-	-	-	-	-	
							S	1,8	3,5	320	140.000	500	F	40	65	0,8	S	x	
							W	3,0	5,0	280	140.000	350	A	40	65	0,8	K	x	
ADJUSTABLE ENERGY	P	AE	36X15	L	50	H	0,1	5,0	400	140.000	400	D	40	65	0,8	D	x		
							M	-	-	-	-	-	-	-	-	-	-	-	
							S	-	-	-	-	-	F	40	65	0,8	S	x	
							W	-	-	-	-	-	A	40	65	0,8	K	x	

## PROTECTION

no protection	Felt ring	Wiper (NBR)
D -A	F -A	A -A
in a clean environment	against dust, chips, ...	against liquid, oil, ...

## TECHNICAL DRAWINGS

	Short piston rod no head	Long piston rod no head	with steel head	with plastic head
	N D -A	N E -A	N S -A	N K -A
STANDARD ENERGY	 M36x1.5, 155, 24, 46, 10, 4.5, 12, 30, 125, 730g	 165, 30, 10, 40, 125, 740g	 170, 30, 22, 31, 15, 125, 800g	 170, 30, 22, 31, 15, 125, 800g
HIGH ENERGY	 M36x1.5, 156, 24, 46, 10, 4.5, 12, 30, 126, 760g	 166, 30, 10, 40, 126, 770g	 171, 30, 22, 31, 15, 126, 830g	 171, 30, 22, 31, 15, 126, 830g
ADJUSTABLE ENERGY	 M36x1.5, 173, 24, 46, 10, 23.6, 3, M5, 4.5, 12, 30, 17, 126, 810g	 183, 30, 10, 40, 126, 820g	 188, 30, 22, 31, 15, 126, 880g	 188, 30, 22, 31, 15, 126, 880g

	Short piston rod no head	Long piston rod no head	with steel head	with plastic head
	L D -A	L E -A	L S -A	L K -A
HIGH ENERGY	 M36x1.5, 221, 24, 46, 10, 4.5, 12, 50, 171, 1030g	 231, 50, 10, 60, 171, 1040g	 236, 50, 22, 31, 15, 171, 1100g	 236, 50, 22, 31, 15, 171, 1100g
ADJUSTABLE ENERGY	 M36x1.5, 238, 24, 46, 10, 23.6, 3, M5, 4.5, 12, 50, 17, 171, 1070g	 248, 50, 10, 60, 171, 1080g	 253, 50, 22, 31, 15, 171, 1140g	 253, 50, 22, 31, 15, 171, 1140g



# INDUSTRIAL SHOCK ABSORBERS POWERSTOP

## THREAD M36X1.5

### ACCESSORIES

Pos.	Order no.	Accessories	Remarks
①	<b>PAH36X15-A</b>	Stop sleeve	Including 1x PVM36X15-A. Industrial shock absorber with bellow excluded.
②	<b>PBV36X15ND-A</b>	Side load adapter standard stroke Protection: no protection	Impact angle max. 30°. Can only be used in combination with industrial shock absorber without protection and without the Short piston rod no head variant. Lock nut PVM45X15-A suitable for external thread of the side load adapter.
③	<b>PBV36X15NF-A</b>	Side load adapter standard stroke Protection: felt ring (felt)	Impact angle max. 30°. Can only be used in combination with industrial shock absorber without protection and without the Short piston rod no head variant. Lock nut PVM45X15-A suitable for external thread of the side load adapter.
④	<b>PBV36X15NA-A</b>	Side load adapter standard stroke Protection: wiper (NBR)	Impact angle max. 30°. Can only be used in combination with industrial shock absorber without protection and without the Short piston rod no head variant. Lock nut PVM45X15-A suitable for external thread of the side load adapter.
⑤	<b>PBV36X15LD-A</b>	Side load adapter long stroke Protection: no protection	Impact angle max. 30°. Can only be used in combination with industrial shock absorber without protection and without the Short piston rod no head variant. Lock nut PVM45X15-A suitable for external thread of the side load adapter.
⑥	<b>PBV36X15LF-A</b>	Side load adapter long stroke Protection: felt ring (felt)	Impact angle max. 30°. Can only be used in combination with industrial shock absorber without protection and without the Short piston rod no head variant. Lock nut PVM45X15-A suitable for external thread of the side load adapter.
⑦	<b>PBV36X15LA-A</b>	Side load adapter long stroke Protection: wiper (NBR)	Impact angle max. 30°. Can only be used in combination with industrial shock absorber without protection and without the Short piston rod no head variant. Lock nut PVM45X15-A suitable for external thread of the side load adapter.
⑧	<b>PKS36X15-A</b>	Clamping flange orthogonal screwed	Tightening torque of the screws max. 45 Nm.
⑨	<b>PKP36X15-A</b>	Clamping flange screwed in parallel	Tightening torque of the screws max. 22 Nm.
⑩	<b>PVM36X15-A</b>	Stainless steel locknut	Included with the industrial shock absorber.
⑪	<b>PDD36X15-A</b>	Pressure chamber seal	On request. Recommended fixing with PVM36x15-A. Seal must be in full contact on both sides.

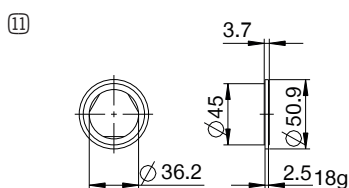
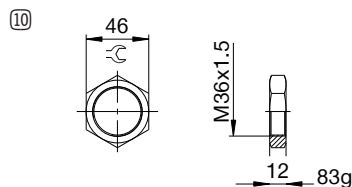
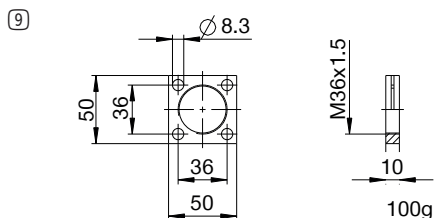
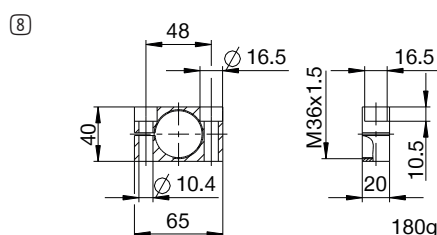
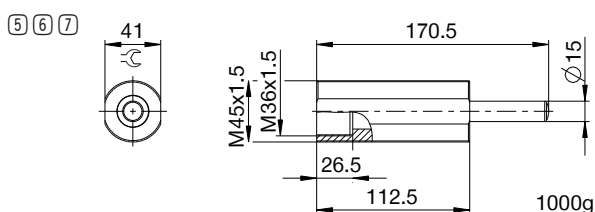
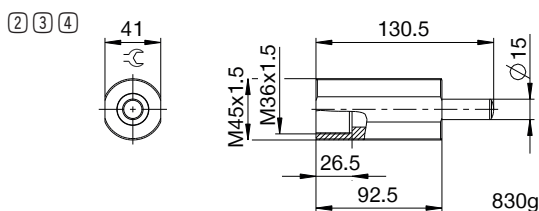
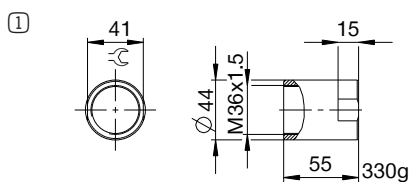



## ▶ CLASSIFICATION

**P** **HE** **36X15** **L** **H** **A** **K** **-A**

### Design

**P** Industrial shock absorbers PowerStop

### Series

**ME** Mini Energy

**SE** Standard Energy

**HE** High Energy

**AE** Adjustable Energy

### Thread

**36** Thread nominal diameter

**X**

**15** Thread pitch (factor 10)

### Stroke variant

**N** Standard stroke

**L** Long stroke

### Hardness degree

**H** Hard (0.1 - 1.2 m/s; Adjustable Energy: 0.1 - 5 m/s)

**M** Medium (0.8 - 2.2 m/s)

**S** Soft (1.8 - 3.5 m/s)

**W** Supersoft (3 - 5 m/s)

### Protection

**D** no protection

**F** Felt ring

**A** Wiper (NBR)

**B** Bellow (TPE)

### Head

**D** Short piston rod no head

**E** Long piston rod no head

**S** with steel head

**K** with plastic head

### Version

**-A** Versioning from a to z

# INDUSTRIAL SHOCK ABSORBERS POWERSTOP

## CUSTOM SOLUTIONS AND SYSTEMS

### ► SPECIAL SOLUTIONS

#### End position damping in hydraulic cylinder



- The damper was designed specifically for use in hydraulic cylinders.
- The hydraulic oil from the cylinder itself is used for damping.
- Ideal and predefined damping characteristics via the integrated spiral groove.

#### Shock absorbers for pallet circulation systems



- Specially tailored shock absorbers for applications with greatly varying, moving masses and/or velocities, whereby, however, the end position should always be reached.
- Integrated valve connections make it possible to cover large energy and velocity ranges with independent adjustment so that the mass reaches the end position safely
- Ideal for use in pallet circulation systems.

#### Heavy load emergency stop damper

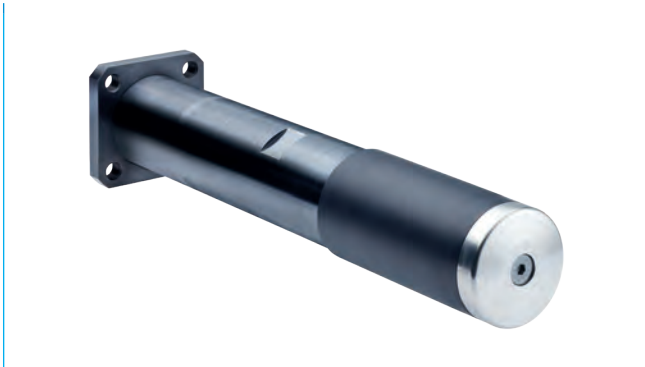

- Customer-specific special solutions for robot portal systems.
- Dampers made from coated steel with an energy absorption of 6,500 Nm per stroke.
- The damper has a damping stroke of 100 mm and an outer diameter of 60 mm.

#### Sliding door dampers



- Customer-specific special solutions for sliding glass doors.
- Dampers made from high-strength aluminum with an energy absorption of 100 Nm per stroke.
- The damper has a damping stroke of 30 mm and an outer diameter of 20 mm.

## ► SPECIAL SOLUTIONS

### I-Class emergency stop shock absorber



- The intelligent solution for emergency stop applications where the shock absorber is operated constantly but damping only occurs in an emergency.
- Damping is triggered only after reaching a preset velocity.
- For example, use on machine tool axles that do not require damping during workpiece machining, but which move with rapid traverse in the event of an emergency stop.

### Twin damping as accessory

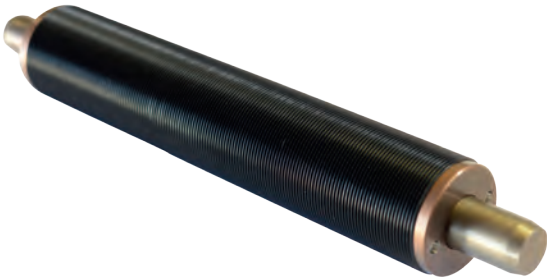

- Installation of a shock absorber in the twin damping accessory enables the activation of the shock absorber from both sides.
- This space- and cost-saving solution transforms a single-action into a dual-action shock absorber.
- For a representation of the principle see Tip 5 page 132.

### Air barrier adapter



- An air barrier adapter is recommended if there is increased dirt buildup.
- Connecting a compressed air supply enables an air cushion to protect the shock absorbers from the ingress of dirt particles.
- The basis for this is the PBV side load adapter, which increases the permissible angle of impact to 30°.

### Hinge dampers



- For the gentle damping of doors, folding tables or other rotational applications.
- Industrial shock absorber with spiral groove integrated into the hinge.
- Converts the rotational movement into linear damping.

# INDUSTRIAL SHOCK ABSORBERS POWERSTOP SPECIAL SOLUTIONS AND SYSTEMS

## ► SYSTEMS

### Dampers for Ottobock prosthetic knee and hip joints

The medical technology company Ottobock, with its head office in Duderstadt, Germany, is the global market leader in the prosthetics segment. The goal of returning mobility to people with handicaps and protecting the functions they still have encompasses the entire product world of the company.

ottobock.



For many years now, the "Knee and Hip Development" department of Ottobock has been working together closely with the "Industrial Damping Technology" division of Zimmer Group. Zimmer is active here as an innovative development partner. Many dampers have been developed together and are used in leg external prosthetic devices from Ottobock.



- Use in prosthetic knee and hip joints for damping swing and standing phases
- Individually adjustable dampers in pull and push directions
- Adjustment of the curve to movement processes
- High energy absorption for the smallest space



# INDUSTRIAL SHOCK ABSORBERS POWERSTOP SHOCK ABSORBERS WITH A DNA STRUCTURE

When James Watson and Francis Crick revealed the structure of human DNA in 1953, they answered the question of how so much genetic information can be stored biologically in such a small space: the simple, yet ingenious, helix structure. From a geometric perspective, a helix is a strand of material wound around a cylinder to create a spiral shape. Everyday examples include pressure springs or the threads of a screw. Today, the same structure that fascinated biochemical researchers at that time is revolutionizing the way industrial shock absorbers work. This industrial helix structure is called a spiral groove.

Technologies: Spiral groove vs. throttle bores

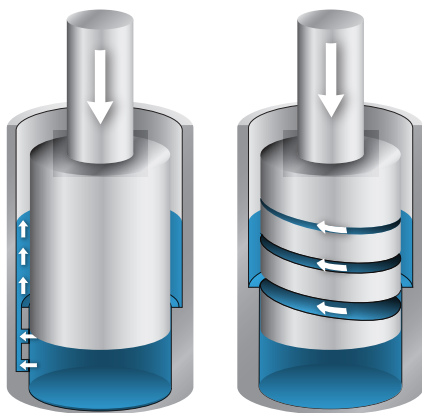

Confronted with the question of how to overcome the drawbacks of conventional throttle bore shock absorbers used in industry, researchers at Zimmer Group developed spiral groove technology, which provides the necessary throttling of an oil flow in a completely new way. This innovative technology, which has since been used in the "PowerStop" shock absorbers from Zimmer Group (technology area: Industrial Damping Technology), places competitor products in the shade with regard to the highest energy absorption in the smallest space and low-vibration damping of moving masses.

Conventional industrial shock absorbers work according to the throttle bore principle, which utilizes holes to throttle the flow of oil. The damping effect is produced as the retracting piston causes openings arranged above the stroke to close one at a time. Unfortunately, this design creates a multi-step damping characteristic, resulting in oscillation. These vibrations can cause damage to the system and result in uneven breaking of the mass. Of course, this defeats the purpose of dampers, which are used specifically to avoid damage to components and achieve smooth stopping of an object.

Throttle bores:  
Throttle type and characteristics

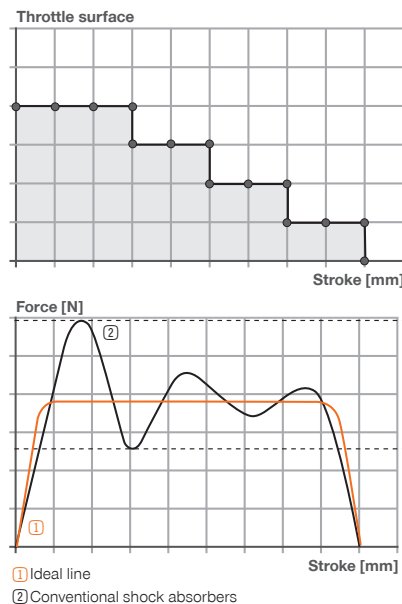

Spiral groove:  
Throttle type and characteristics

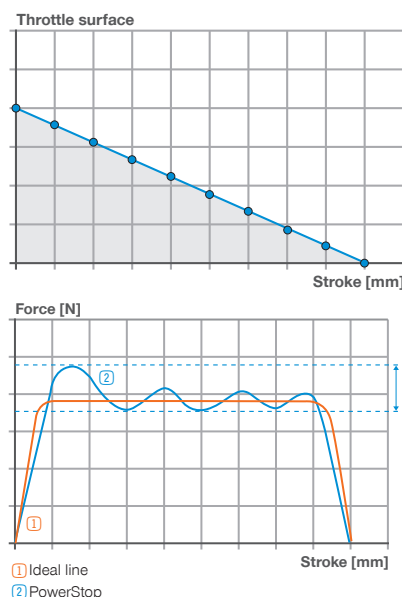

Even throttle behavior

Only PowerStop shock absorbers with the unique spiral groove technology can achieve these goals. In the process, a spiral groove around the circumference of the piston ensures even throttle behavior. The groove itself tapers as it moves up the piston, resulting in smooth and even damping characteristics. Only this design can achieve low-oscillation damping and smooth braking of an object in motion.

At the same time, optimized loads at every piston position enable maximum energy absorption with low space requirements. On top of this, the flow of oil in the spiral groove ensures that there is always a film of oil between the moving piston and the housing. This hydrostatic piston movement lays the foundation for low-wear components that maximize service life.

A wide variety of standard components for the most varied damping requirements is available for your systems and equipment. In addition, through flexible adaptation of the spiral groove, a special damper designed for particular uses can be provided as a semi-standard component. Developers from the Industrial Damping Technology division can also create complete, customized system solutions for you.

Individual damping characteristics

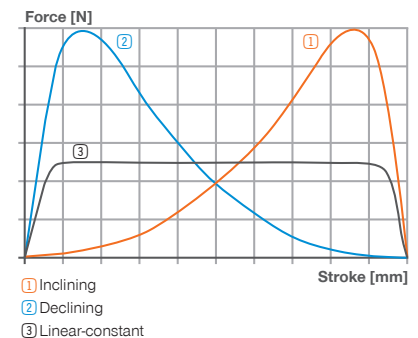

Zimmer Group has the experience and know-how to support its customers as a development partner in the field of damping technology. Its PowerStop series of industrial shock absorbers provides users with complete solutions for virtually any set of requirements and operating conditions, ensuring that the customer always has the optimal damping tool possible, true to the motto, "When in doubt, damp it out!"



# PROFILE DAMPERS

## BASICSTOP



# PROFILE DAMPERS BASICSTOP

## KNOW-HOW

The BasicStop profile dampers feature high-performance plastic and a specifically developed profile.

It acquires its unique properties after receiving a special treatment. These properties allow it to absorb maximum amounts of energy even under the toughest conditions, while also achieving high damping rates.



### Our expertise – your advantages:

- ▶ TPC high-performance plastic:  
Thermoplastic elastomer on a copolyester basis  
High durability and resistance to media\*  
No swelling, embrittlement or decomposition of the material, as is the case with rubber\*  
Large temperature range
- ▶ Special process for conditioning the material:  
High damping percentage and high energy absorption in the smallest space  
Reliable return behavior  
Increased service life in comparison to rubber pads
- ▶ Design of the structure:  
Standard product portfolio with 3 series x 2 degrees of hardness  
Individual configuration for customized solutions possible
- ▶ Expertise in design and production at Zimmer
- ▶ Usability independent of velocity
- ▶ 100% recyclable due to thermoplastic properties

\* For chemical and media resistance see page 108



## Function

- ▶ Unlike hydraulic industrial shock absorbers, material dampers do not damp 100% of the absorbed energy. Instead, they convert only a specific percentage of the kinetic energy into heat. This is called the damping percentage. The residual energy, on the other hand, is stored in the material as spring energy, which is released again when the damper is reset.
- ▶ Conventional rubber pads only have a very small damping percentage and are more of a spring than a damper. Use of these pads hardly takes any kinetic energy from the system, which in turn can lead to damage to the system.
- ▶ This is where the BasicStop brand profile dampers are setting new standards in the realm of material damping with their high damping percentage. Through the friction in the material, a large part of the kinetic energy is converted into heat, whereupon the structural damper returns to its original form (viscoelastic damping).

## Damping vs. springing

### Impact energy

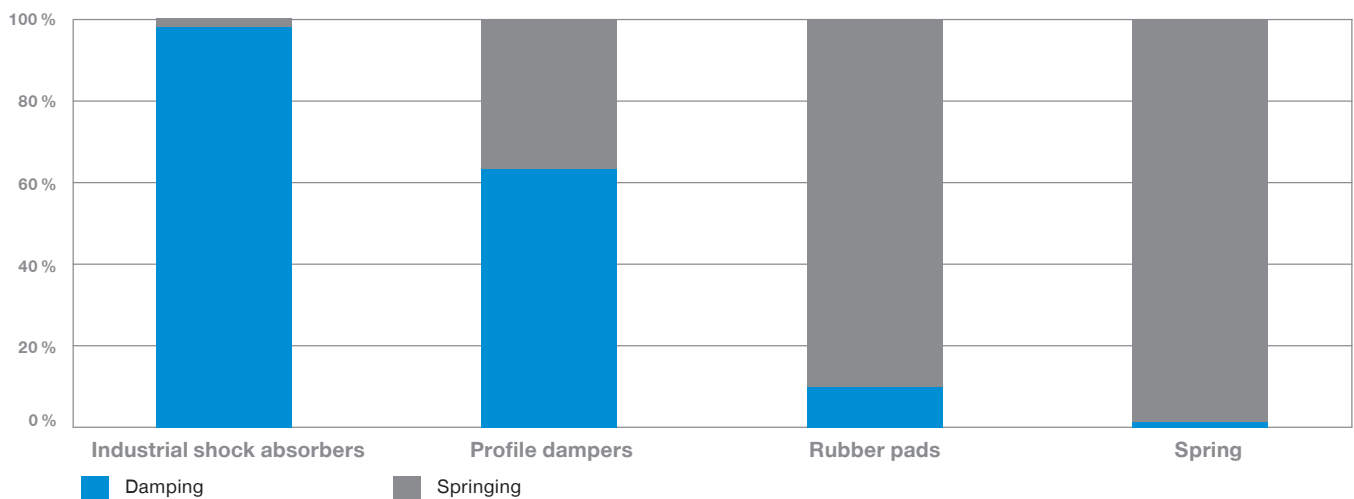

## Service life

- ▶ Rubber materials fail after certain intervals of time due to settling losses, creep behavior, media incompatibility or overloading, which results in high maintenance costs for the user. With BasicStop, long service life is achieved even under the toughest conditions, which dispenses with unnecessary maintenance costs.

## Characteristics and damping percentage of the shock absorber curve

- ▶ The characteristic of the shock absorber curve for force over stroke is dependent upon the structural design of the respective series, but, in contrast with hydraulic shock absorbers, the impact velocity has no effect on the characteristic. This is why material dampers can be used irrespective of the velocity.
- ▶ However, the damping percentage depends upon the impact velocity. This increases in certain areas with increasing velocity, until it reaches its maximum. The damping percentage also increases with an increasing degree of hardness of the TPC.

# PROFILE DAMPERS BASICSTOP

## THE SERIES AT A GLANCE



### Axial Standard

- ▶ Design: Axial
- ▶ Degrees of hardness: 55D, 40D
- ▶ Energy absorption per stroke: 0,3 - 2.951 J
- ▶ Damping percentage: up to 75%

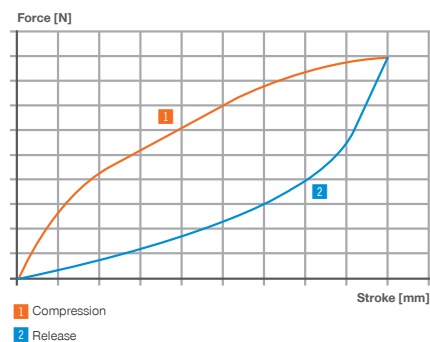

### Axial Advanced

- ▶ Design: Axial
- ▶ Degrees of hardness: 55D, 40D
- ▶ Energy absorption per stroke: 450 - 17,810 J
- ▶ Damping percentage: up to 65%

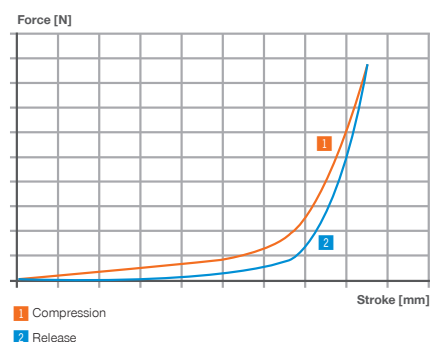

### Radial Standard

- ▶ Design: Radial
- ▶ Degrees of hardness: 55D, 40D
- ▶ Energy absorption per stroke: 1.2 - 427 J
- ▶ Damping percentage: up to 60%

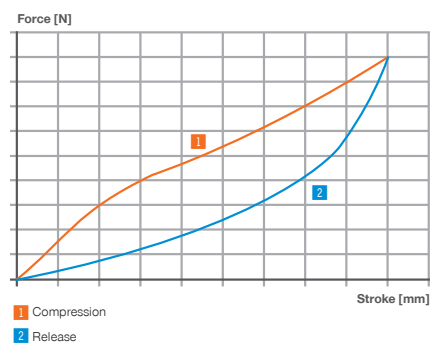

# PROFILE DAMPERS BASICSTOP

## FUNCTIONAL SEQUENCE

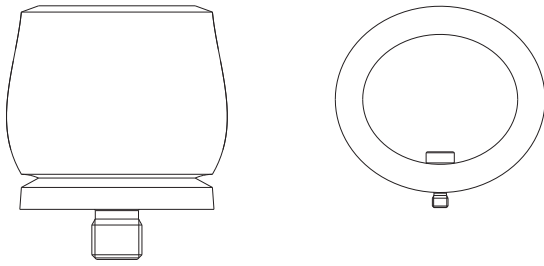

### 1. Home position

Unstressed in unshaped state.

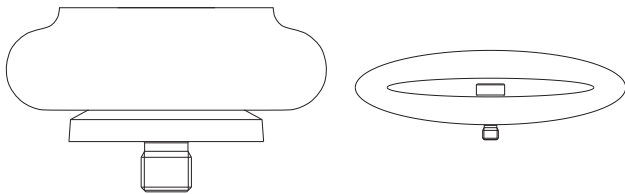

### 2. Compression with damping

External force or kinetic energy (impact) compresses the profile damper

- ▶ Walls are deformed by the stroke and expand or curve outward due to the structural design.
- ▶ Due to the structural structure of the material body, a force (damping or supporting force) is generated via the stroke that counters the movement.
- ▶ Due to the friction inside the TPC material, a large proportion of the kinetic energy is transformed into heat (**viscoelastic damping**).

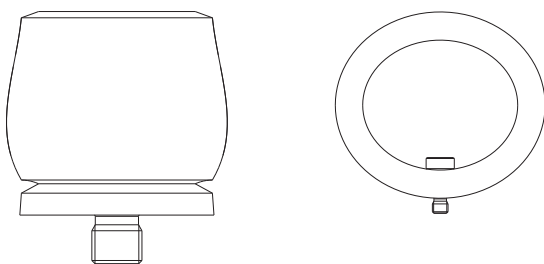
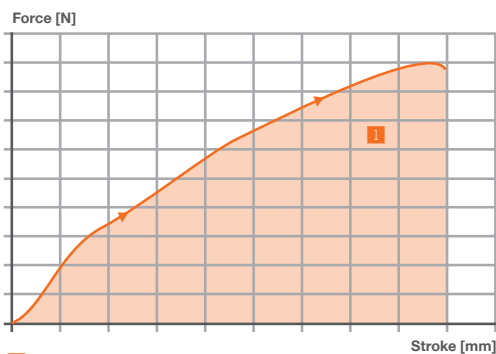

### 3. Returning

- ▶ The part of the kinetic energy that is not damped during the stroke is stored as spring energy in the material body (**viscoelastic damping**).
- ▶ This spring energy causes a return of the body to the starting position via the return stroke (**viscoelastic damping**).
- ▶ Rebound of the mass as long as the acting force of the mass is less than the return force of the structural damper.
- ▶ Ratio of damping energy to kinetic energy in the impact is designated as damping percentage.

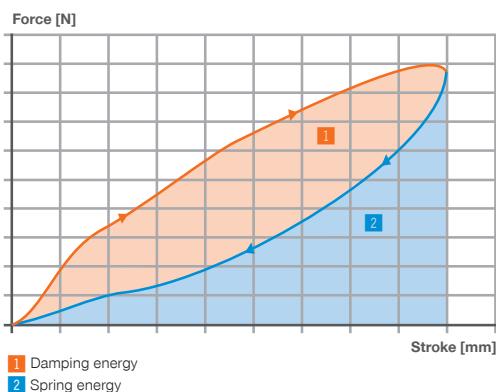

# PROFILE DAMPERS BASICSTOP

## CHEMICAL AND MEDIA RESISTANCE

Chemicals	Effect
Acetone	Weak
Acetylene	None
Formic acid (diluted)	Weak
Aniline	Strong
ASTM oil No. 1 (149°C)	None
ASTM oil No. 3 (149°C)	None
ASTM reference fuel A	None
ASTM reference fuel B (70°C)	None
ASTM reference fuel C (70°C)	Weak
ASTM reference fuel C	None
Gasoline	None
Benzene	Weak
Beer	None
Bromine, liquid free of water	Strong
Butane	None
Butyl acetate	Weak
Calcium chloride solutions	None
Chlorine gas, wet and dry	Strong
Chloroacetic acid	Strong
Chlorobenzene	Strong
Chloroform	Strong
Chlorosulfuric acid	Strong
Citric acid solutions	None
Cyclohexane	None
Steam (110°C)	Strong
Dibutyl phthalate	None
Diethyl sebacate	None
Diocetyl phthalate	None
Iron(III)-chloride solutions	Weak
Glacial acetic acid	None
Epichlorohydrin	Strong
Acetic acid, 20% - 30%	None
Ethanol	None
Ethyl acetate	Weak
Ethyl chloride	Strong
1,2-dichloroethane	Strong
Ethylene glycol	None
Ethylene oxide	None
Fluoric acid, 48%	Strong
Fluoric acid, 75%	Strong
Fluoric acid, free from water	Strong
Formaldehyde, 40%	Weak
Freon 11, 12, 114	None
Freon 113 (54°C)	None
Glycerin	None
Isooctane	None
Isopropanol	None
Jet Fuel JP-4	None
Potassium hydroxide solutions (diluted)	None
Kerosene	Weak
Carbon dioxide	None
Carbon monoxide	None
Copper chloride solutions	None
Copper sulfate solutions	None
Paint solvent	Weak
Linseed oil	Strong
Magnesium chloride solutions	Strong

Chemicals	Effect
Magnesium hydroxide solutions	Strong
Sea water	None
Methanol	None
Methylene chloride	Strong
Butanone	Weak
Mineral oil	None
Naphtha	None
Naphthalene	Weak
Sodium chloride solutions	None
Sodium hydroxide, 20%	None
n-hexane	None
Nitrobenzene	Strong
Oil SAE 10	None
Oleum, 20% - 25%	Strong
Oleic acid	None
Palmitic acid	None
Perchloroethylene	Strong
Phenol	Strong
Pyridine	Strong
Nitric acid, 10%	Weak
Nitric acid, 30% - 70%	Strong
Nitric acid, strong/red fuming	Strong
Hydrochloric acid, 20%	Weak
Hydrochloric acid, 37%	Strong
Sulfuric acid, 50%	Strong
Sulfurous acid	Weak
Soap solutions	None
Silicone grease	None
Skydrol 500B	None
Tannin, 10%	None
Carbon tetrachloride	Strong
Tetrahydrofuran	Weak
Toluene	Weak
Trichloroethylene	Strong
Triethanolamine	Strong
Trisodium phosphate solution	None
Tung oil	Weak
Water (70°C)	Weak
Hydrogen	None
Xylene	Weak
Zinc chloride solutions	None

### Classification of effect:

- ▶ **None:** No sustained reaction, as almost no absorption and almost no effect on mechanical properties.
- ▶ **Weak:** Minor effect due to a certain absorption with slight swelling and slight worsening of the mechanical properties.
- ▶ **Strong:** Use not recommended, as material changes for the worse in a short time.

No guarantee or liability is provided or assumed for this chemical and media resistance list. It is only meant as a point of reference. Other chemical and media resistances upon request or checking through own tests.

# PROFILE DAMPERS BASICSTOP

## PRODUCT KEY

### Selection of profile dampers

- ▶ by series, installation size and degree of hardness

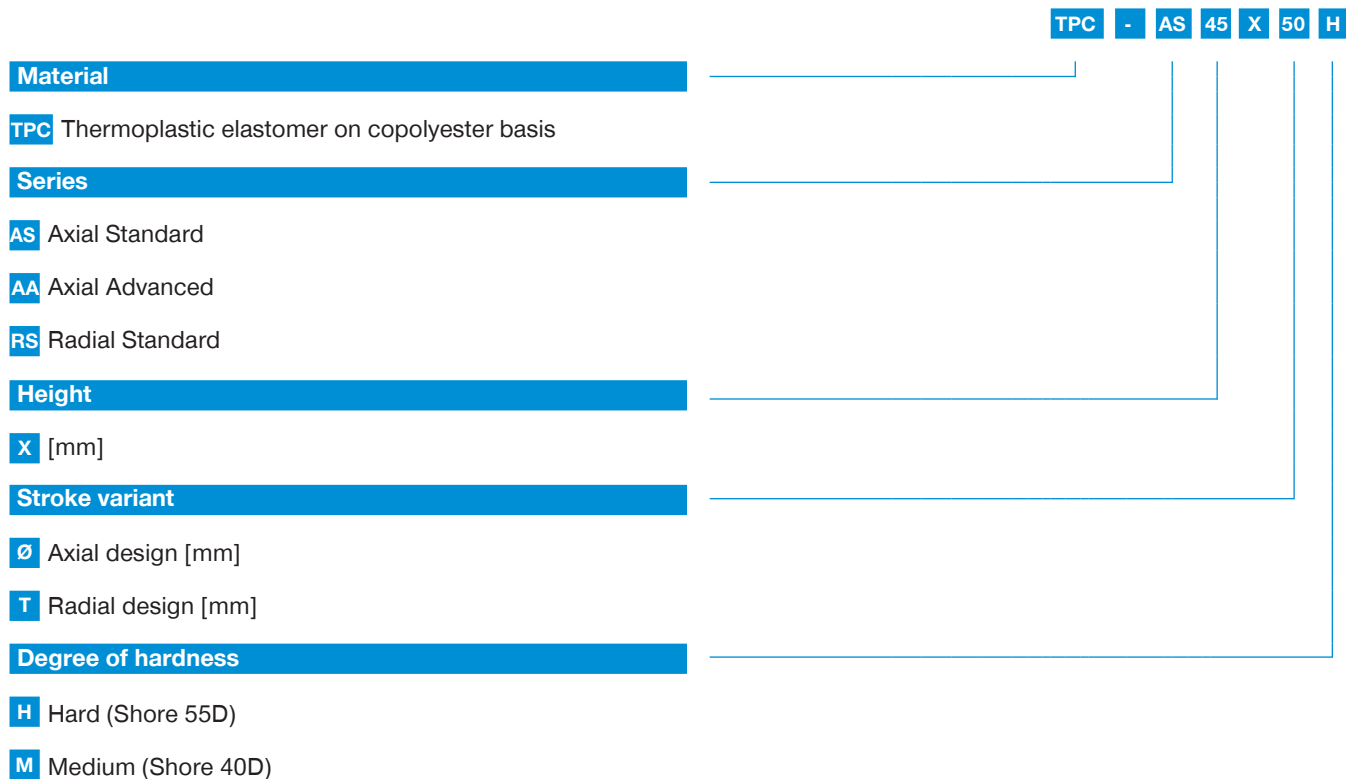

### Note:

- ▶ Delivery including a nickel-plated special screw for simple and safe installation.
- ▶ The energy absorption and the impact velocity can be determined using the shock absorber selection guide online at [www.zimmer-group.com/pdti](http://www.zimmer-group.com/pdti) or the forms and calculations listed in the catalog.
- ▶ For the installation space, use the dimensions without loads and at complete deformation.

# PROFILE DAMPERS BASICSTOP APPLICATIONS

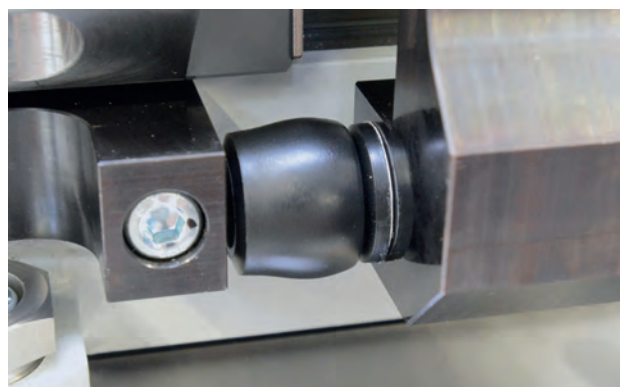

▶ Emergency stop protection in the movement axis of a spindle tailstock

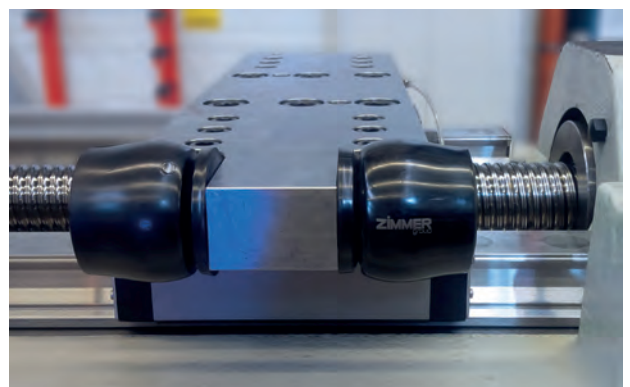
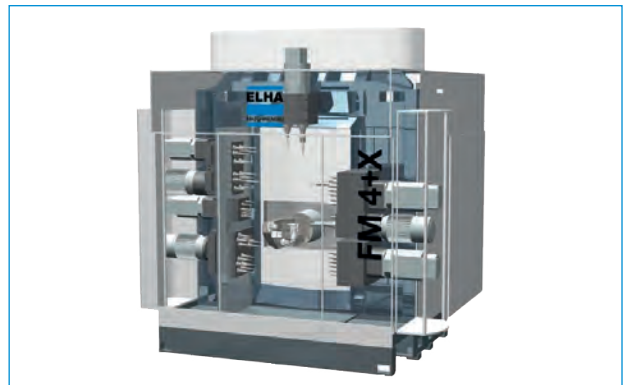

▶ End-position damping in the linear axes of production modules from ELHA



▶ Machine door damping in a machining center



▶ Emergency stop damping on a portal crane





▶ Connecting multiple BasicStop Axial Standard including integrated round shaft guides for shock absorption with low support load through large stroke in series



▶ Tractive force conversion: Connecting multiple BasicStop Axial Standard with tie rod in series, for example, to reduce rope tension in the event of impact loading

# PROFILE DAMPERS BASICSTOP

## OVERVIEW OF PRODUCTS

	Series	Degree of hardness	Max. energy absorption per stroke [J]		Stroke [mm]	Thread M	Page
			Continuous operation	Emergency stop operation			
	AXIAL STANDARD	Shore 55D	0,5-2014	0,8-2951	3-48	M2-M16	112
		Shore 40D	0,3-902	0,4-966	3-56	M2-M16	112
	AXIAL ADVANCED	Shore 55D/ Shore 40D	450-12725	630-17810	30-198	M12-M20	114
	RADIAL STANDARD	Shore 55D	2,7-290	5,7-427	15-56	M5-M8	116
		Shore 40D	1,2-115	1,8-146	17-60	M5-M8	116

# PROFILE DAMPERS BASICSTOP SERIES AXIAL STANDARD

## ▶ PRODUCT SPECIFICATIONS



▶ <b>Design</b>	Axial
▶ <b>Shore hardness, hard</b>	55D
▶ <b>Shore hardness, medium</b>	40D
▶ <b>Damping proportion Hard</b>	up to 75 %
▶ <b>Damping proportion Medium</b>	up to 65 %
▶ <b>Impact speed</b>	0,1 ... 5,0 [m/s]
▶ <b>Permitted temperature range</b>	-50 ... +90 [°C]
▶ <b>Angle of Impact max.</b>	15 [°]
▶ <b>PWIS-free</b>	Yes
▶ <b>RoHS compliant</b>	Yes
▶ <b>REACH compliant</b>	Yes

## ▶ TECHNICAL DATA

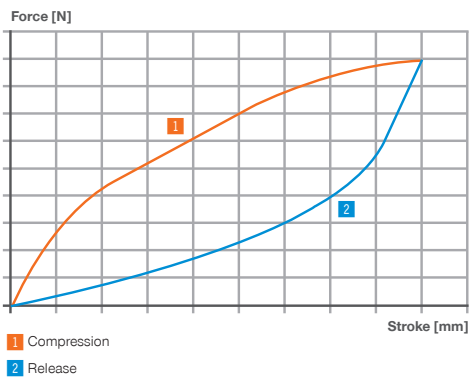

### ▶ Installation instructions

#### Order No.

TPC-M2-A  
TPC-M3-A  
TPC-M4-A  
TPC-M5-A  
TPC-M6-A  
TPC-M8-A  
TPC-M12-A  
TPC-M16-A

Thread	Wrench size [mm]	Tightening torque [Nm]	Weight [g]
M2	1.3	0.3	1
M3	2	1	1
M4	2.5	2	1
M5	3	3	2
M6	5	5	4
M8	6	12	13
M12	10	40	29
M16	14	100	94

The profile dampers must completely contact the underside.  
The screws are included in the scope of delivery of the respective BasicStop structural damper. These can also be ordered individually.

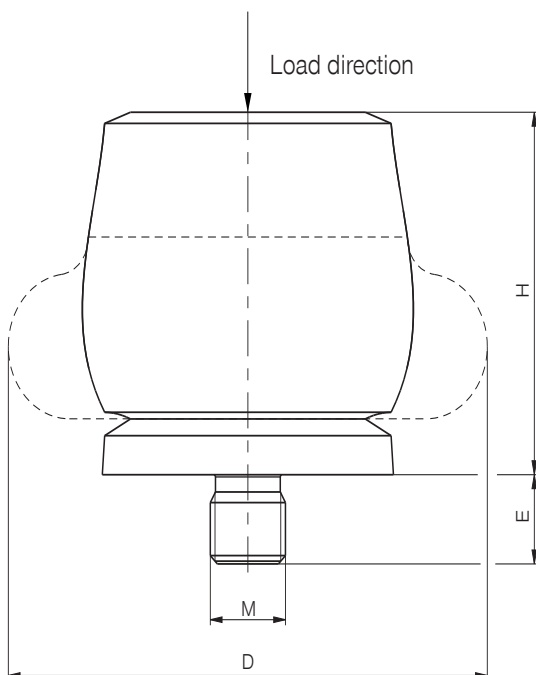



## TECHNICAL DATA

### Axial Standard

Order No.	Energy absorption max.		Stroke max.	Height H	Diameter D			Max. screw-in depth E	Thread	Weight (incl. screw)
	Continuous operation				Stroke=0	Stroke=0	Stroke=max.			
	per stroke	per hour	Emergency stop operation							
	[J]	[J/h]	per stroke	[mm]	[mm]	[mm]	[mm]	[mm]	[g]	
TPC-AS7X8H	0.5	15	0.8	3	7	8	9	2	M2	1
TPC-AS11X12H	2	60	3	5	11	12	15	3	M3	1
TPC-AS16X17H	6	180	9	6	16	17	21	4	M4	4
TPC-AS18X21H	10	300	16	9	18	21	26	5	M5	6
TPC-AS19X22H	11.5	345	21	9	19	22	27	6	M6	9
TPC-AS26X28H	29	870	46	12	26	28	36	6	M6	15
TPC-AS30X34H	48	1,440	87	14	30	34	43	6	M6	22
TPC-AS33X37H	65	1,950	112	16	33	37	48	6	M6	28
TPC-AS35X39H	82	2,460	130	16	35	39	50	8	M8	41
TPC-AS38X43H	112	3,360	165	18	38	43	55	8	M8	53
TPC-AS41X46H	140	4,200	173	19	41	46	59	12	M12	77
TPC-AS45X50H	170	5,100	223	22	45	50	64	12	M12	86
TPC-AS47X53H	201	6,030	334	22	47	53	68	12	M12	100
TPC-AS51X57H	242	7,260	302	24	51	57	73	12	M12	117
TPC-AS54X62H	304	9,120	361	25	54	62	77	12	M12	131
TPC-AS57X65H	374	11,220	468	27	57	65	82	12	M12	152
TPC-AS60X69H	421	12,630	524	29	60	69	86	12	M12	174
TPC-AS65X71H	482	14,460	559	31	65	71	91	16	M16	258
TPC-AS69X79H	570	17,100	831	32	69	79	100	16	M16	312
TPC-AS74X82H	683	20,490	921	35	74	82	105	16	M16	348
TPC-AS76X85H	797	23,910	1043	36	76	85	109	16	M16	385
TPC-AS80X89H	934	28,020	1249	38	80	89	114	16	M16	431
TPC-AS86X97H	1147	34,410	1555	40	86	97	123	16	M16	516
TPC-AS101X116H	2014	60,420	2951	48	101	116	146	16	M16	803

Order No.	per stroke	per hour	Emergency stop operation	Stroke=0	Stroke=0	Stroke=max.	Max. screw-in depth E	Thread	Weight (incl. screw)	
	[J]	[J/h]	[J]	[mm]	[mm]	[mm]	[mm]		[g]	
TPC-AS7X7M	0.3	9	0.4	3	7	7	9	2	M2	1
TPC-AS12X11M	0.9	27	1.4	6	12	11	15	3	M3	1
TPC-AS15X14M	2	60	3	7	15	14	19	4	M4	2
TPC-AS19X17M	4	120	6	9	19	17	24	5	M5	6
TPC-AS21X20M	6	180	7	11	21	20	27	6	M6	8
TPC-AS28X26M	11.5	345	15	14	28	26	37	6	M6	13
TPC-AS32X31M	23	690	26	16	32	31	44	6	M6	20
TPC-AS36X35M	30	900	36	19	36	35	48	6	M6	25
TPC-AS38X37M	34	1,020	42	19	38	37	51	6	M6	31
TPC-AS41X41M	48	1,440	63	21	41	41	55	12	M12	63
TPC-AS45X44M	63	1,890	72	23	45	44	60	12	M12	69
TPC-AS49X48M	81	2,430	91	25	49	48	64	12	M12	80
TPC-AS52X51M	92	2,760	114	27	52	51	69	12	M12	91
TPC-AS55X54M	122	3,660	158	29	55	54	73	12	M12	107
TPC-AS59X58M	149	4,470	154	31	59	58	78	12	M12	123
TPC-AS62X61M	163	4,890	169	32	62	61	83	16	M16	200
TPC-AS66X64M	208	6,240	254	34	66	64	87	16	M16	227
TPC-AS69X68M	227	6,810	272	35	69	68	92	16	M16	247
TPC-AS75X75M	291	8,730	408	38	75	75	101	16	M16	292
TPC-AS79X77M	352	10,560	459	40	79	77	105	16	M16	314
TPC-AS84X82M	419	12,570	620	44	84	82	110	16	M16	347
TPC-AS85X84M	475	14,250	635	43	85	84	115	16	M16	395
TPC-AS92X90M	580	17,400	778	47	92	90	124	16	M16	463
TPC-AS109X107M	902	27,060	966	56	109	107	147	16	M16	698

# PROFILE DAMPERS BASICSTOP SERIES AXIAL ADVANCED

## ▶ PRODUCT SPECIFICATIONS



▶ <b>Design</b>	Axial
▶ <b>Shore hardness, hard</b>	55D
▶ <b>Shore hardness, medium</b>	40D
▶ <b>Damping proportion Hard</b>	up to 65 %
▶ <b>Damping proportion Medium</b>	up to 65 %
▶ <b>Impact speed</b>	0,1 ... 5,0 [m/s]
▶ <b>Permitted temperature range</b>	-50 ... +90 [°C]
▶ <b>Angle of Impact max.</b>	15 [°]
▶ <b>PWIS-free</b>	Yes
▶ <b>RoHS compliant</b>	Yes
▶ <b>REACH compliant</b>	Yes

## ▶ TECHNICAL DATA

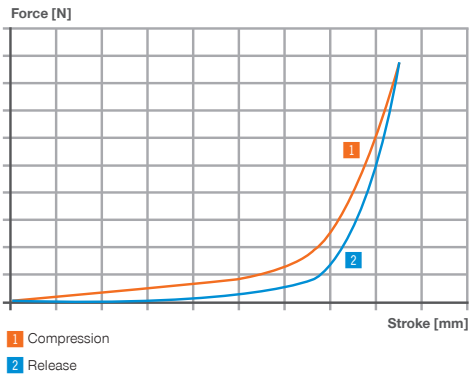

### ▶ Installation instructions

#### Order No.

**TPC-M12-A**

**TPC-M16-A**

**TPC-M20-A**

Thread	Wrench size [mm]	Tightening torque [Nm]	Weight [g]
M12	10	40	29
M16	14	100	94
M20	14	185	190

The profile dampers must completely contact the underside.  
The screws are included in the scope of delivery of the respective BasicStop structural damper. These can also be ordered individually.

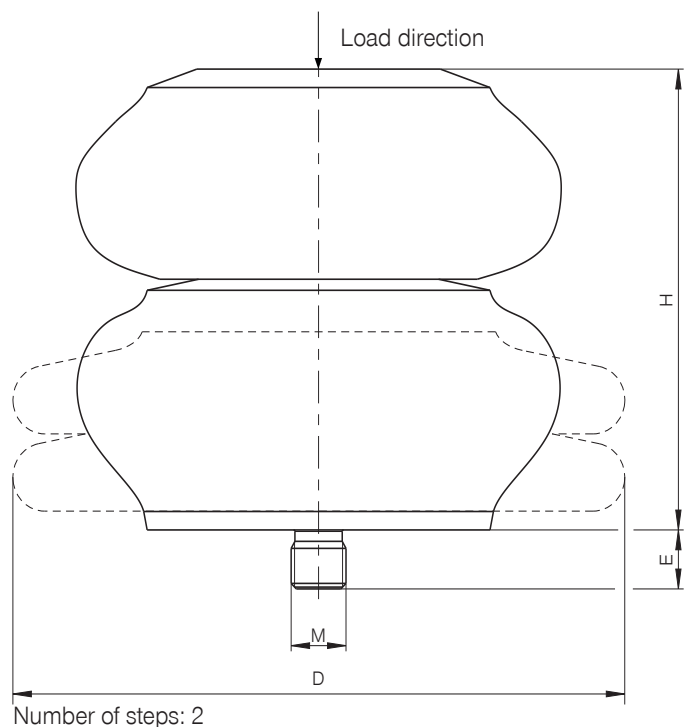
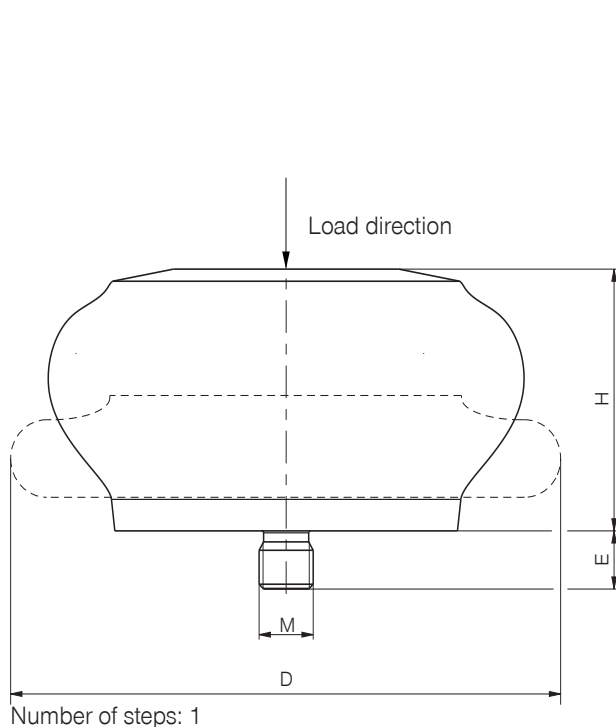

## TECHNICAL DATA

### ► Axial Advanced

	Order No.	Energy absorption max.			Stroke max.	Height H	Diameter D			Number of steps	Max. screw-in depth E	Thread	Weight (incl. screw)
		Continuous operation		Emergency stop operation			Stroke=0	Stroke=0	Stroke=max.				
		per stroke	per hour										
		[J]	[J/h]	[J]			[mm]	[mm]	[mm]				
MEDIUM / HARD	<b>TPC-AA79X64M</b>	450	13,500	630	62	79	64	89	2	12	M12	177	
	<b>TPC-AA96X74M</b>	980	29,400	1372	75	96	74	114	2	12	M12	241	
	<b>TPC-AA57X88M</b>	1210	36,300	1695	40	57	88	133	1	12	M12	285	
	<b>TPC-AA68X88H</b>	1640	49,200	2295	49	68	88	124	1	12	M12	286	
	<b>TPC-AA84X100M</b>	1785	53,550	2500	59	84	100	149	1	12	M12	515	
	<b>TPC-AA53X108H</b>	1900	57,000	2660	30	53	108	133	1	12	M12	394	
	<b>TPC-AA94X85M</b>	1940	58,200	2715	74	94	85	127	2	12	M12	325	
	<b>TPC-AA98X102H</b>	1970	59,100	2760	63	98	102	140	1	16	M16	645	
	<b>TPC-AA129X116M</b>	3710	111,300	5195	97	129	116	187	1	16	M16	1062	
	<b>TPC-AA106X136H</b>	4250	127,500	5950	65	106	136	178	1	16	M16	1195	
	<b>TPC-AA114X137M</b>	6350	190,500	8890	89	114	137	216	1	16	M16	1129	
	<b>TPC-AA224X152M</b>	7260	217,800	10165 *	176	224	152	241	2	20	M20	2370	
	<b>TPC-AA186X140M</b>	7310	219,300	10230 *	144	186	140	214	2	16	M16	1596	
	<b>TPC-AA118X146H</b>	8330	249,900	11660 *	67	118	146	191	2	16	M16	1535	
	<b>TPC-AA241X149M</b>	8860	265,800	12400 *	178	241	149	224	2	20	M20	2589	
<b>TPC-AA166X168M</b>	10100	303,000	14140 *	124	166	168	260	1	16	M16	2297		
<b>TPC-AA252X177M</b>	12725	381,750	17810 *	198	252	177	279	2	20	M20	3161		

\* Limit angle of impact in emergency stop operation to 2°

# PROFILE DAMPERS BASICSTOP

## SERIES RADIAL STANDARD

### ▶ PRODUCT SPECIFICATIONS



▶ <b>Design</b>	Radial
▶ <b>Shore hardness, hard</b>	55D
▶ <b>Shore hardness, medium</b>	40D
▶ <b>Damping proportion Hard</b>	up to 60 %
▶ <b>Damping proportion Medium</b>	up to 50 %
▶ <b>Impact speed</b>	0,1 ... 5,0 [m/s]
▶ <b>Permitted temperature range</b>	-50 ... +90 [°C]
▶ <b>Angle of Impact max.</b>	30 [°]
▶ <b>PWIS-free</b>	Yes
▶ <b>RoHS compliant</b>	Yes
▶ <b>REACH compliant</b>	Yes

### ▶ TECHNICAL DATA

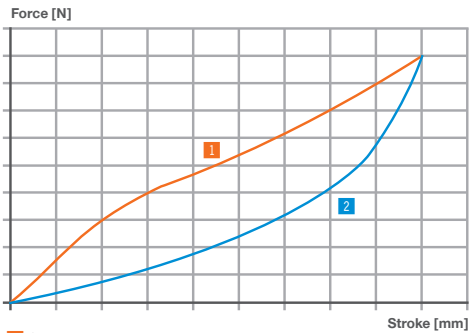

1 Compression  
2 Release

#### ▶ Installation instructions

##### Order No.

**TPC-M5-R**  
**TPC-M6-R**  
**TPC-M8-R**

Thread	Wrench size [mm]	Tightening torque [Nm]	Weight [g]
M5	3	3	3
M6	5	5	6
M8	6	12	14

The profile dampers must completely contact the underside.  
The screws are included in the scope of delivery of the respective BasicStop structural damper. These can also be ordered individually.

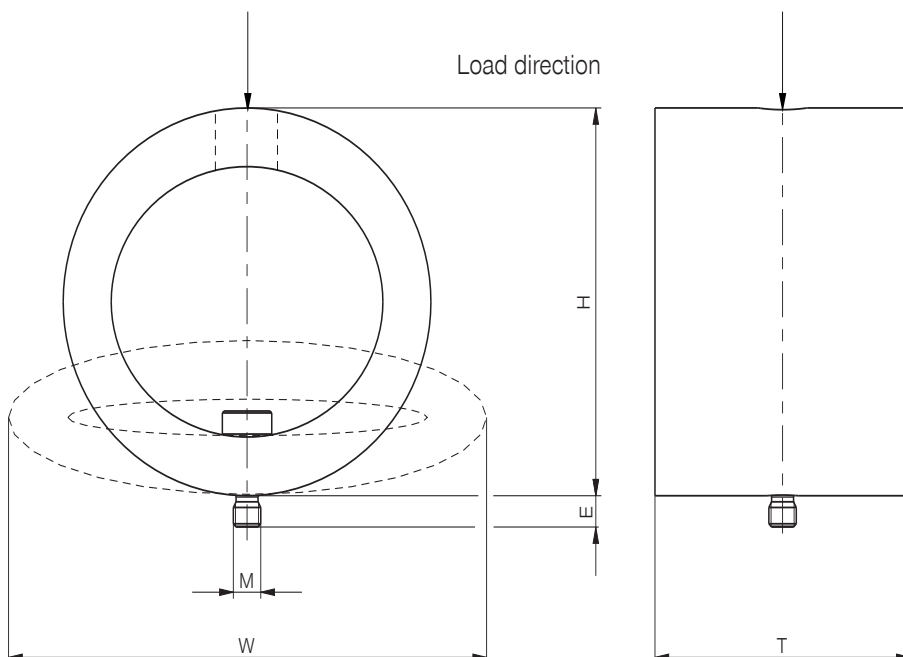

## TECHNICAL DATA

### Radial Standard

	Order No.	Energy absorption max.			Stroke max.	Height H			Width W	Depth T	Max. screw-in depth E	Thread	Weight (incl. screw)
		Continuous operation		Emergency stop operation		Stroke=0	Stroke=0	Stroke=max					
		per stroke	per hour										
		[J]	[J/h]	[J]	[mm]	[mm]	[mm]	[mm]	[mm]	[mm]		[g]	
<b>HARD</b>	TPC-RS23X13H	2.7	81	5.7	15	23	30	38	13	5	M5	4	
	TPC-RS30X19H	6	180	18	19	30	39	50	19	5	M5	11	
	TPC-RS36X20H	8.7	261	24	23	36	45	58	20	5	M5	16	
	TPC-RS42X34H	11.7	351	20	32	42	52	68	34	5	M5	25	
	TPC-RS53X43H	25	750	46	41	53	64	87	43	5	M5	51	
	TPC-RS56X46H	66.5	1,995	98	37	56	68	88	46	6	M6	80	
	TPC-RS64X46H	81.5	2,445	106	42	64	79	102	46	6	M6	105	
	TPC-RS69X51H	124	3,720	206	46	69	86	109	51	6	M6	146	
	TPC-RS69X67H	158	4,740	261	46	69	86	111	67	8	M8	190	
	TPC-RS77X82H	228	6,840	342	50	77	95	124	82	8	M8	266	
TPC-RS84X81H	290	8,700	427	56	84	102	133	81	8	M8	319		
<b>MEDIUM</b>	TPC-RS25X13M	1.2	36	1.8	17	25	28	38	13	5	M5	6	
	TPC-RS32X19M	2.3	69	5.4	21	32	37	50	19	5	M5	13	
	TPC-RS37X20M	3.5	105	8.1	25	37	42	58	20	5	M5	17	
	TPC-RS44X35M	5.8	174	8.3	34	44	50	68	35	5	M5	26	
	TPC-RS55X43M	12	360	17	43	55	63	87	43	5	M5	51	
	TPC-RS59X46M	23	690	33	40	59	66	88	46	6	M6	77	
	TPC-RS67X46M	34.5	1,035	43	46	67	76	102	46	6	M6	104	
	TPC-RS73X51M	45	1,350	74	50	73	83	109	51	6	M6	142	
	TPC-RS73X67M	68	2,040	92	50	73	85	111	67	8	M8	206	
	TPC-RS83X83M	92	2,760	122	57	83	93	124	83	8	M8	297	
TPC-RS88X81M	115	3,450	146	60	88	100	133	81	8	M8	335		



# INDUSTRIAL DAMPING TECHNOLOGY

## GENERAL

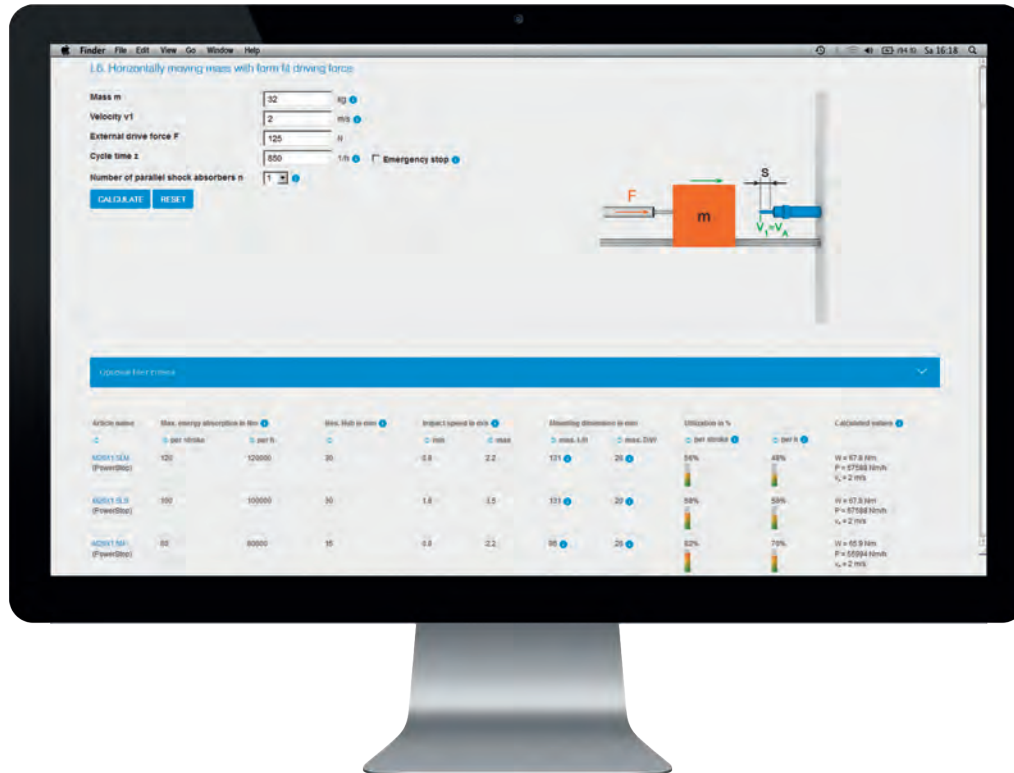

# GENERAL CALCULATION

## ► BASES FOR CALCULATION

### ► Overview of formula symbols

Formula symbols	Explanation	Unit
F	External drive force	N
$F_{SD}$	Maximum force of a shock absorber	N
$F_{SDges}$	Minimum total shock absorber force	N
g	Gravitational acceleration	m/s <sup>2</sup>
h	Height	m
J	Moment of inertia (based on the instant center)	kg·m <sup>2</sup>
k	Number of dampers in series	-
L	Distance of center of mass from the instant center	m
m	Dimensions	kg
M	External drive torque	Nm
n	Number of parallel dampers	-
P	Energy per hour per damper	J/h
$P_{ges}$	Total energy per hour	J/h
R	Damper distance to the instant center	m
s	Resulting stroke of a damper	m
$S_{ges}$	Resulting total damper stroke	m
$v_0$	Initial velocity of the mass in the center of mass	m/s
$v_1$	Velocity of the mass in the center of mass at the mark	m/s
$v_A$	Impact velocity of the mass on the shock absorber	m/s
W	Energy per stroke per damper	J
$W_1$	Kinetic energy at impact	J
$W_2$	Additional kinetic energy during stroke of a shock absorber	J
$W_{2ges}$	Total additional energy during total damper stroke	J
$W_{ges}$	Total energy per stroke	J
z	Number of strokes per hour	1/h
$\alpha$	Angle of impact	°
$\beta$	Pitch angle	°
$\mu$	Coefficient of friction	-
$\omega_0$	Initial angular velocity of the mass in the center of mass	1/s
$\omega_1$	Angular velocity of the mass in the center of mass at the mark	1/s
$\omega_A$	Impact angular velocity of the mass on the shock absorber	1/s



## ▶ GENERAL FORMULAS

▶ General formulas	
	Formula
<b>Acceleration due to gravity</b>	Standard acceleration: $g = 9,80665 \frac{m}{s^2}$
<b>Kinetic energy at impact</b>	Translational movement: $W_1$ depending on load case, general: $W_1 = \frac{1}{2} \cdot m \cdot v_A^2$
	Rotational movement: $W_1$ depending on load case, general: $W_1 = \frac{1}{2} \cdot J \cdot \omega_A^2$
<b>Additional kinetic energy during stroke</b>	Per damper: $W_2$ depending on load case
	Total: $W_{2ges} = W_2 \cdot k$
<b>Energy per stroke</b>	Per damper: $W = W_{ges} : (n \cdot k) = (W_1 + W_{2ges}) : (n \cdot k)$
	Total: $W_{ges} = W_1 + W_{2ges}$
<b>Energy per hour</b>	Per damper: $P = P_{ges} : (n \cdot k) = (W_{ges} \cdot z) : (n \cdot k) = W \cdot z$
	Total: $P_{ges} = W_{ges} \cdot z$
<b>Impact velocity and impact angular velocity</b>	Impact velocity: $v_A$ depending on load case
	Impact angular velocity: $\omega_A = \frac{v_A}{R}$
<b>Angle of impact</b>	Translational movement: $\alpha$ depending on application
	Rotational movement: $\alpha = \arcsin \frac{s \cdot k}{R} = \arcsin \frac{s_{ges}}{R}$
<b>Resulting stroke</b>	Per damper: $s$ depending on damper properties
	Total: $s_{ges} = s \cdot k$
<b>Resulting force</b>	Per damper: $F_{SD}$ depending on shock absorber properties
	Total: $F_{SDges} = F_{SD} \cdot n$

- ▶ Calculation of  $W_1$ ,  $W_2$  and  $v_A$  according to the example load cases listed below, where they are sub-classified into translational and rotational movements.

# GENERAL CALCULATION

## ▶ LOAD CASES: TRANSLATIONAL

### L1. Free-falling mass

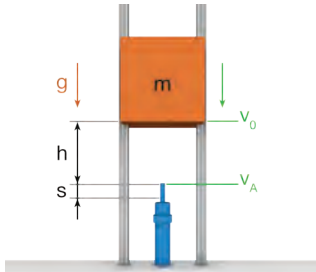

$$W_1 = \frac{1}{2} \cdot m \cdot v_0^2 + m \cdot g \cdot h$$

$$W_2 = m \cdot g \cdot s$$

$$v_A = \sqrt{v_0^2 + 2 \cdot g \cdot h}$$

### L2. Downward moving mass with opposing drive force

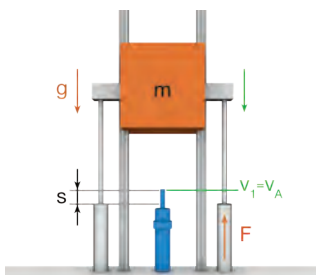

$$W_1 = \frac{1}{2} \cdot m \cdot v_1^2$$

$$W_2 = m \cdot g \cdot s - F \cdot s$$

$$v_A = v_1$$

## ▶ LOAD CASES: ROTATIONAL

### R1. Freely oscillating mass a) at horizontal impact

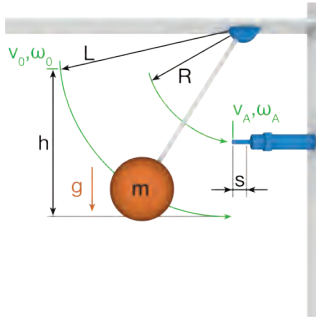

$$W_1 = \frac{1}{2} \cdot J \cdot \omega_0^2 + m \cdot g \cdot h$$

$$W_2 = 0$$

$$v_A = \sqrt{(\omega_0 \cdot L)^2 + 2 \cdot g \cdot h} \cdot \frac{R}{L} = \sqrt{v_0^2 + 2 \cdot g \cdot h} \cdot \frac{R}{L}$$

### R1. Freely oscillating mass b) at vertical impact

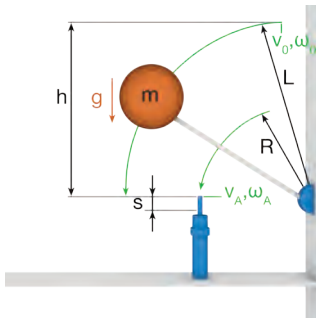

$$W_1 = \frac{1}{2} \cdot J \cdot \omega_0^2 + m \cdot g \cdot h$$

$$W_2 = m \cdot g \cdot \frac{L}{R} \cdot s$$

$$v_A = \sqrt{(\omega_0 \cdot L)^2 + 2 \cdot g \cdot h} \cdot \frac{R}{L} = \sqrt{v_0^2 + 2 \cdot g \cdot h} \cdot \frac{R}{L}$$

### R2. Downward pivoting mass with opposing drive torque a) at horizontal impact

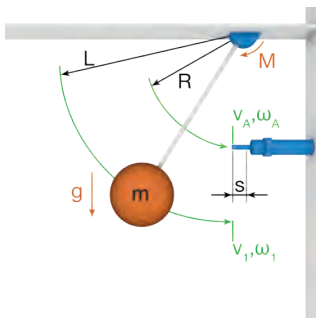

$$W_1 = \frac{1}{2} \cdot J \cdot \omega_1^2$$

$$W_2 = -\frac{M}{R} \cdot s$$

$$v_A = \omega_1 \cdot R = v_1 \cdot \frac{R}{L}$$

### R2. Downward pivoting mass with opposing drive torque b) at vertical impact

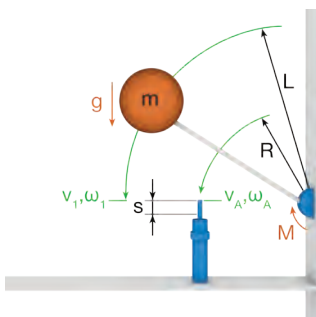

$$W_1 = \frac{1}{2} \cdot J \cdot \omega_1^2$$

$$W_2 = m \cdot g \cdot \frac{L}{R} \cdot s - \frac{M}{R} \cdot s$$

$$v_A = \omega_1 \cdot R = v_1 \cdot \frac{R}{L}$$

# GENERAL CALCULATION

## ► LOAD CASES: TRANSLATIONAL

### L3. Downward moving mass with drive force

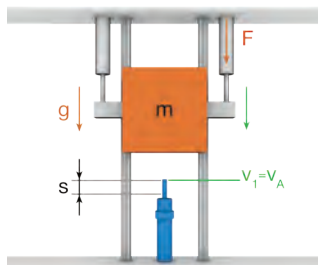

$$W_1 = \frac{1}{2} \cdot m \cdot v_1^2$$

$$W_2 = F \cdot s + m \cdot g \cdot s$$

$$v_A = v_1$$

### L4. Upward moving mass with drive force

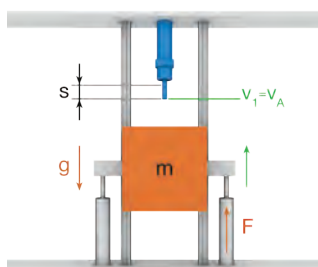

$$W_1 = \frac{1}{2} \cdot m \cdot v_1^2$$

$$W_2 = F \cdot s - m \cdot g \cdot s$$

$$v_A = v_1$$

► LOAD CASES: ROTATIONAL

R3. Downward pivoting mass with drive torque

a) at horizontal impact

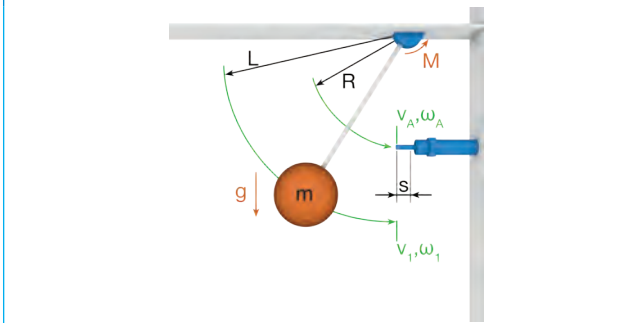

$$W_1 = \frac{1}{2} \cdot J \cdot \omega_1^2$$

$$W_2 = \frac{M}{R} \cdot s$$

$$v_A = \omega_1 \cdot R = v_1 \cdot \frac{R}{L}$$

R3. Downward pivoting mass with drive torque

b) at vertical impact

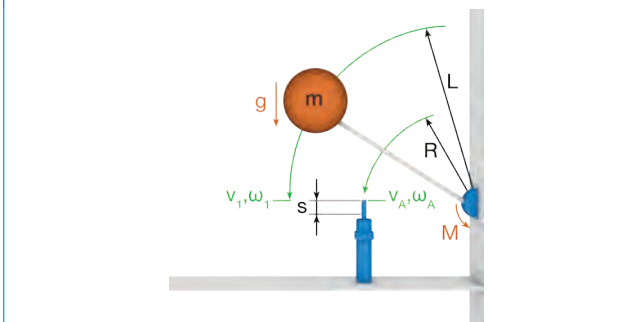

$$W_1 = \frac{1}{2} \cdot J \cdot \omega_1^2$$

$$W_2 = \frac{M}{R} \cdot s + m \cdot g \cdot \frac{L}{R} \cdot s$$

$$v_A = \omega_1 \cdot R = v_1 \cdot \frac{R}{L}$$

R4. Upward pivoting mass with drive torque

a) at horizontal impact

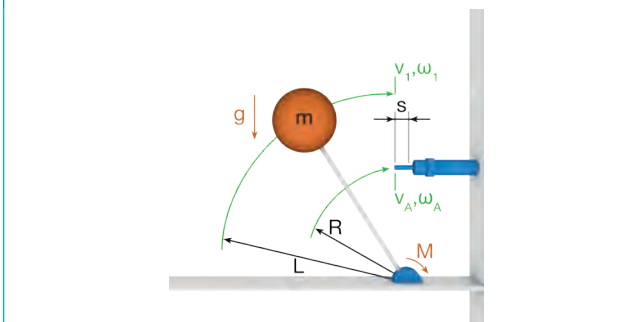

$$W_1 = \frac{1}{2} \cdot J \cdot \omega_1^2$$

$$W_2 = \frac{M}{R} \cdot s$$

$$v_A = \omega_1 \cdot R = v_1 \cdot \frac{R}{L}$$

R4. Upward pivoting mass with drive torque

b) at vertical impact

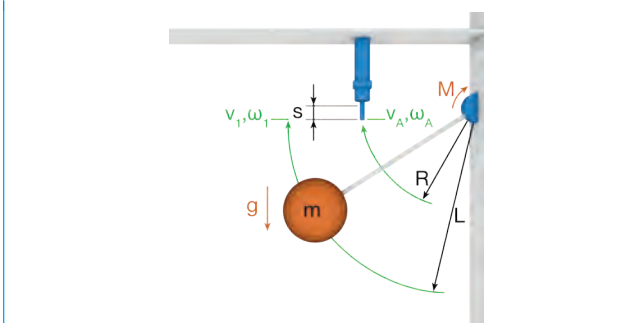

$$W_1 = \frac{1}{2} \cdot J \cdot \omega_1^2$$

$$W_2 = \frac{M}{R} \cdot s - m \cdot g \cdot \frac{L}{R} \cdot s$$

$$v_A = \omega_1 \cdot R = v_1 \cdot \frac{R}{L}$$

# GENERAL CALCULATION

## ► LOAD CASES: TRANSLATIONAL

### L5. Horizontally moving mass without drive force

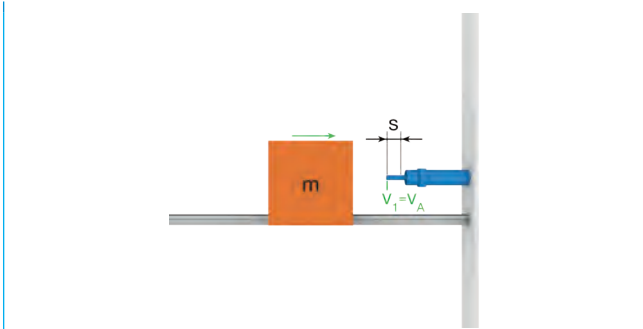

$$W_1 = \frac{1}{2} \cdot m \cdot v_1^2$$

$$W_2 = 0$$

$$v_A = v_1$$

### L6. Horizontally moving mass with form-fit drive force

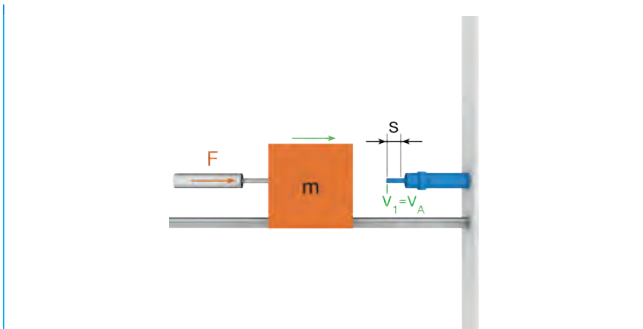

$$W_1 = \frac{1}{2} \cdot m \cdot v_1^2$$

$$W_2 = F \cdot s$$

$$v_A = v_1$$

### L7. Horizontally moving mass with frictional drive force

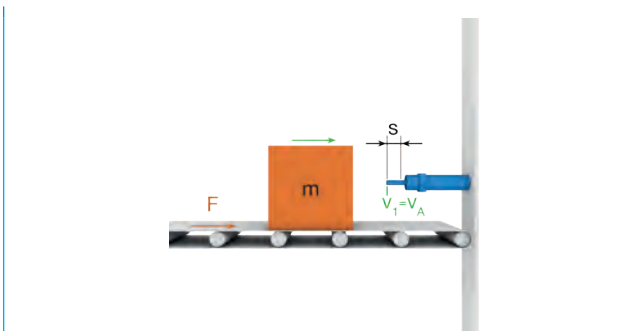

$$W_1 = \frac{1}{2} \cdot m \cdot v_1^2$$

$$W_2 = \mu \cdot m \cdot g \cdot s$$

$$v_A = v_1$$

### L8. Falling mass on an inclined plane

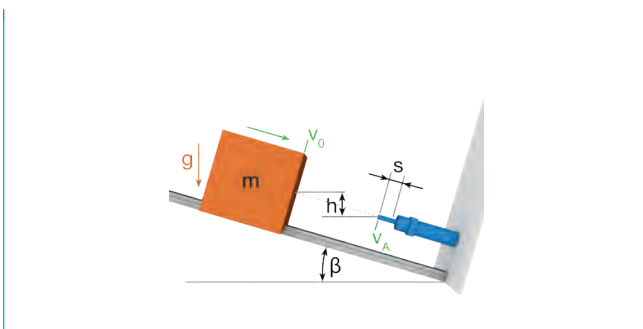

$$W_1 = \frac{1}{2} \cdot m \cdot v_0^2 + m \cdot g \cdot h$$

$$W_2 = \sin\beta \cdot m \cdot g \cdot s$$

$$v_A = \sqrt{v_0^2 + 2 \cdot g \cdot h}$$

## ► LOAD CASES: ROTATIONAL

### R5. Horizontally pivoting mass without drive torque

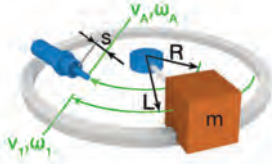

$$W_1 = \frac{1}{2} \cdot J \cdot \omega_1^2$$

$$W_2 = 0$$

$$v_A = \omega_1 \cdot R = v_1 \cdot \frac{R}{L}$$

### R6. Horizontally pivoting mass with form-fit drive torque

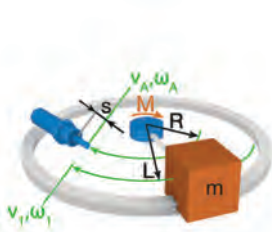

$$W_1 = \frac{1}{2} \cdot J \cdot \omega_1^2$$

$$W_2 = \frac{M}{R} \cdot s$$

$$v_A = \omega_1 \cdot R = v_1 \cdot \frac{R}{L}$$

### R7. Horizontally pivoting mass with frictional drive torque

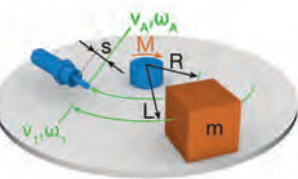

$$W_1 = \frac{1}{2} \cdot J \cdot \omega_1^2$$

$$W_2 = \mu \cdot m \cdot g \cdot \frac{L}{R} \cdot s$$

$$v_A = \omega_1 \cdot R = v_1 \cdot \frac{R}{L}$$

### Note on rotational movement

- To simplify the calculations, it is assumed that the rotationally moving mass at the impact on the damper leaves the path tangentially and the damper acts on this tangential path. Thus the rotational movement energy is completely converted in translational movement energy. For small angles, this simplification provides a sufficient approach.

# GENERAL CALCULATION

## ► LOAD CASES: TRANSLATIONAL

### L9. Downward moving mass with opposing drive force on an inclined plane

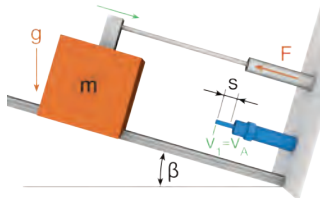

$$W_1 = \frac{1}{2} \cdot m \cdot v_1^2$$

$$W_2 = \sin\beta \cdot m \cdot g \cdot s - F \cdot s$$

$$v_A = v_1$$

### L10. Downward moving mass with drive force on an inclined plane

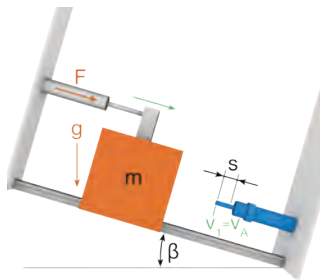

$$W_1 = \frac{1}{2} \cdot m \cdot v_1^2$$

$$W_2 = F \cdot s + \sin\beta \cdot m \cdot g \cdot s$$

$$v_A = v_1$$

### L11. Downward moving mass with drive force on an inclined plane

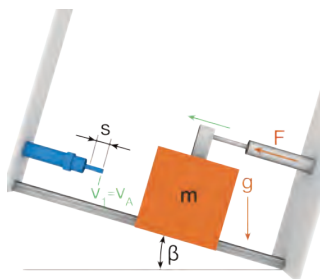

$$W_1 = \frac{1}{2} \cdot m \cdot v_1^2$$

$$W_2 = F \cdot s - \sin\beta \cdot m \cdot g \cdot s$$

$$v_A = v_1$$





# GENERAL CHECKLIST

Customer number	<input type="text"/>	Telephone number	<input type="text"/>
Company	<input type="text"/>	Fax number	<input type="text"/>
Contact	<input type="text"/>	E-mail	<input type="text"/>
<input type="checkbox"/> Mr. <input type="checkbox"/> Mrs.			
<b>Sales data</b>		<b>Article</b>	<input type="text"/>
Editor	<input type="text"/>	Target price	<input type="text"/>
Desired delivery date	<input type="text"/>	Others	<input type="text"/>
Quantity	<input type="text"/>	Pot. quantity (p.a.)	<input type="text"/>
		Date	<input type="text"/>

## Desired damping

- Hydraulic (100% damping)    ▶ Industrial shock absorber (PowerStop)  
 Viscoelastic (up to 75% damping)    ▶ Profile dampers (BasicStop)

## Installation conditions

Application

Replacement competitor  Yes    Manufacturer     Thread     Article

Max. installation space Length / height  mm    Thread / Ø  mm

Environment    Temperature min.  °C    Temperature max.  °C    Pressure  bar

Shavings     Dust     Oil / Grease     Cooling lubricant    Others

## Operating conditions

Load case\*     Number parallel     Number in row

Operation mode  Duration ▶    Cycle time  Strokes/h    Number of cycles  Strokes

Emergency stop ▶    Number of cycles  Strokes

Movement  Translational ▶    Drive force  N    Angle of impact  °

Rotational ▶    Drive torque  Nm

Swivel radius shock absorber  mm    Swivel radius mass  mm

Impact velocity  Translational ▶    min.  m/s    max.  m/s

Rotational ▶    min.  1/s    max.  1/s

Mass / Mass moment of inertia  Translational ▶    min.  kg    max.  kg

Rotational ▶    min.  kg m<sup>2</sup>    max.  kg m<sup>2</sup>

Other (depending on load case) Height  mm    Coefficient of friction     Pitch angle  °

Adjustability    Approvals (such as RoHS, LABS, EG, CE, explosion protection, cleanroom)

## Industrial shock absorber configuration

Protection  without (in a clean environment)     Wiper (against liquid, oil, ...)

Felt (against dust, chips, ...)

Bellow (sealed)

Impact head  no head     Steel head     Plastic head

Accessories      Stop sleeve     Sensor stop sleeve

Clamping flange screwed in parallel     Clamping flange orthogonal screwed     Pressure chamber seal

## Special

Other (oil, characteristic, stroke, size, thread,...)

\* See catalog or [www.zimmer-group.com/de/pdti](http://www.zimmer-group.com/de/pdti)

# LOAD CASES

## Translational

## Rotational

## Translational

## Rotational

L1. Free-falling mass

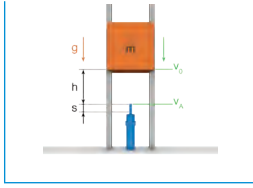

R1. Freely oscillating mass  
a) at horizontal impact

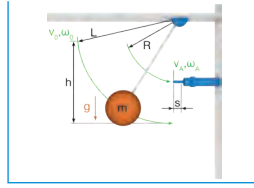

R1. Freely oscillating mass  
b) at vertical impact

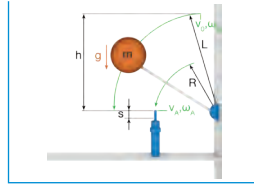

L7. Horizontally moving mass with  
frictional drive force

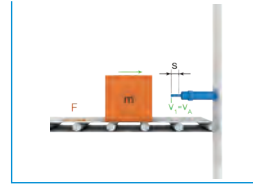

R7. Horizontally pivoting mass with  
frictional drive torque



L2. Downward moving mass with  
opposing drive force

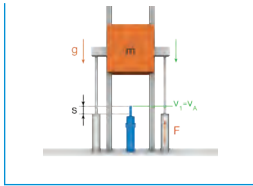

R2. Downward pivoting mass with  
opposing drive torque  
a) at horizontal impact

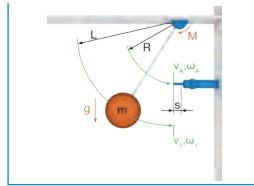

R2. Downward pivoting mass with  
opposing drive torque  
b) at vertical impact

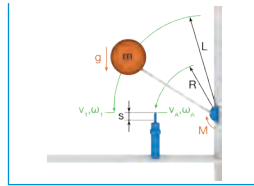

L8. Falling mass on an inclined  
plane

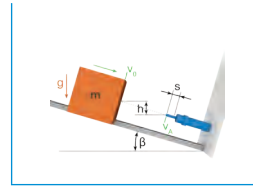

L3. Downward moving mass with  
drive force

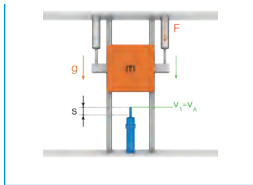

R3. Downward pivoting mass with  
drive torque  
a) at horizontal impact

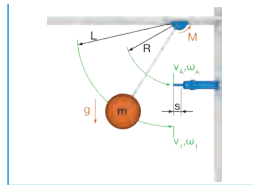

R3. Downward pivoting mass with  
drive torque  
b) at vertical impact

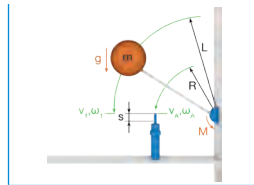

L9. Downward moving mass with  
opposing drive force on an  
inclined plane

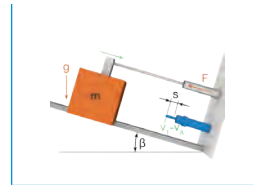

L4. Upward moving mass with  
drive force

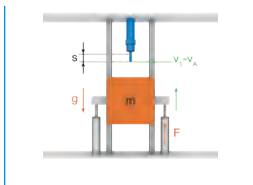

R4. Upward pivoting mass with  
drive torque  
a) at horizontal impact

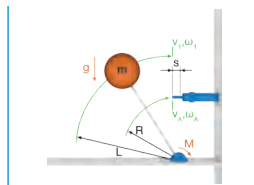

R4. Upward pivoting mass with  
drive torque  
b) at vertical impact

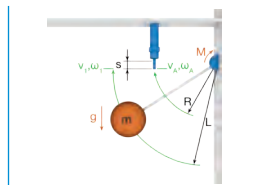

L10. Downward moving mass  
with drive force on an inclined  
plane

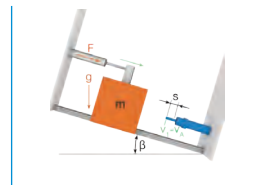

L5. Horizontally moving mass  
without drive force

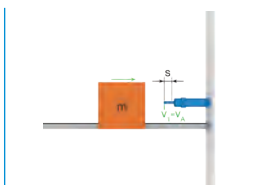

R5. Horizontally pivoting mass  
without drive torque



L6. Horizontally moving mass with  
form-fit drive force

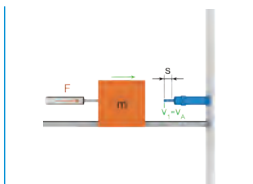

R6. Horizontally pivoting mass with  
form-fit drive torque



# GENERAL TIPS AND TRICKS

## ► TIP 1: Series use of shock absorbers

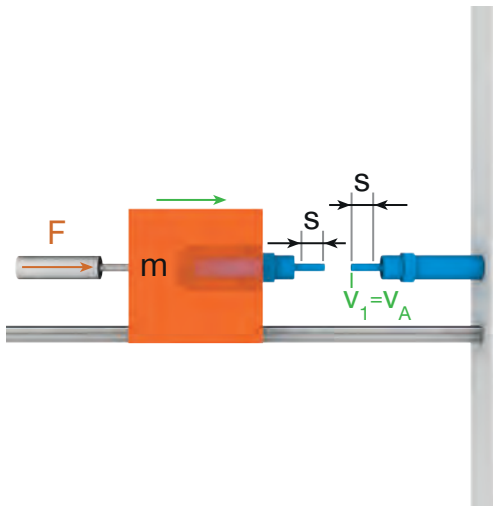

With n shock absorbers in series, n-fold energy absorption capacity through n-fold stroke with the same force.

► Caution: Calculation of the energy per stroke and per hour with n-fold stroke!

► Example of 2 shock absorbers:

Total stroke = 2 x shock absorber stroke

Total shock absorber force = shock absorber force

Total energy absorption capacity = 2 x shock absorber energy absorption capacity

Equal distribution of the total energy to n shock absorbers

► Possibility in comparison to use of only one shock absorber:

Use of the same shock absorber type with reduced utilization or use of a smaller shock absorber type.

► Example of 2 shock absorbers:

Shock absorber energy absorption = Total energy absorption/2

## ► TIP 3: Lever translation

### a) Translation $i < 1$

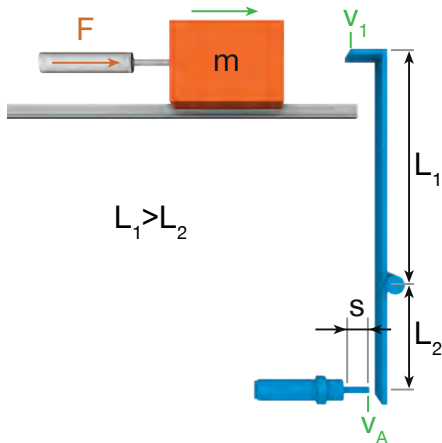

### b) Translation $i > 1$

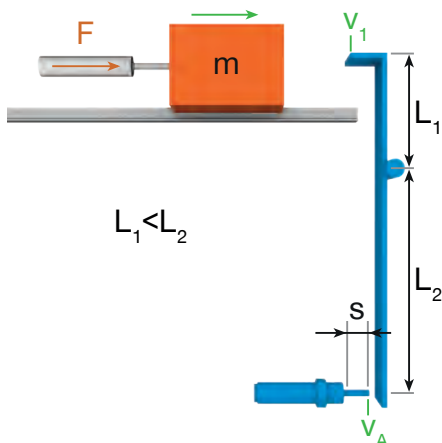

Translation:

$$i = \frac{L_2}{L_1}$$

Indices:

► Parameters at the top end of the lever with mass: Index 1

► Parameters at the bottom end of the lever with shock absorbers: Index A

Modulation of the parameters according to the following principles

	$L_1 > L_2$ ( $i < 1$ )	$L_1 < L_2$ ( $i > 1$ )	Formula
Translation of impact velocity to shock absorbers	Reduction of impact velocity	Increase of impact velocity	$v_A = v_1 \cdot i$
Translation of shock absorbers stroke to mass	Increase of the stroke of the mass	Reduction of the stroke of the mass	$s_1 = \frac{s_A}{i}$
Translation of shock absorbers force to mass	Reduction of force to mass	Increase of force to mass	$F_1 = F_A \cdot i$
Kinetic energy/energy absorption	Identical	Identical	W

► **TIP 2: Parallel connection of shock absorbers**

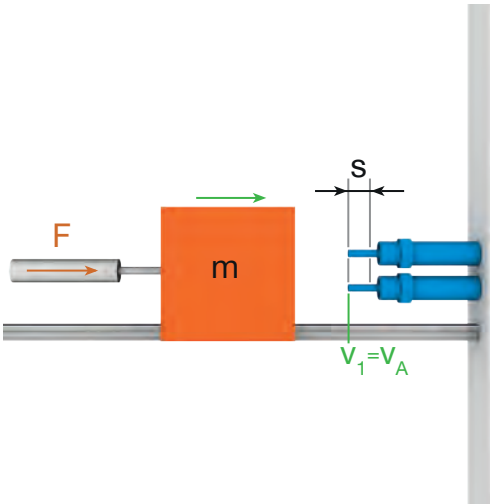

With  $n$  shock absorbers in parallel,  $n$ -fold energy absorption capacity through  $n$ -fold force with the same stroke.

- Calculation of the energy per stroke and per hour remains the same due to identical stroke!
- Example of 2 shock absorbers:  
Total stroke = Shock absorber stroke  
Total shock absorber force = 2 x shock absorber force  
Total energy absorption capacity = 2 x shock absorber energy absorption capacity

Equal distribution of the total energy to  $n$  shock absorbers

- Possibility in comparison to use of only one shock absorber:  
Use of the same shock absorber type with reduced utilization or use of a smaller shock absorber type.
- Example of 2 shock absorbers:  
Shock absorber energy absorption = Total energy absorption/2

► **TIP 4: Transformation of rotational into translational movement**

a) With gear-rack layout

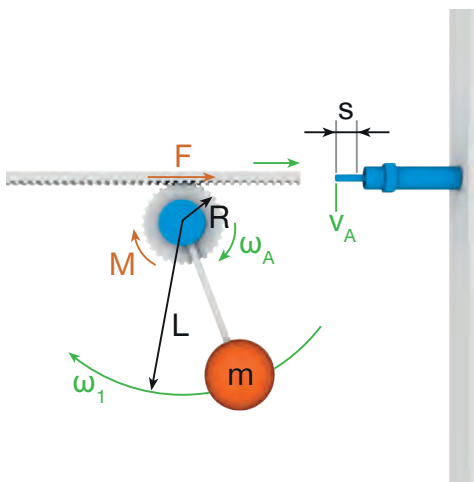

b) With lever mechanism

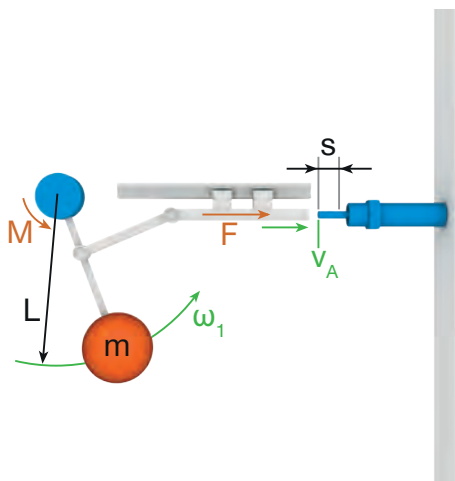

- Translation of a rotational movement into a translational movement with the help of a gear-rack layout (a) or a lever mechanism (b).
- The gear-rack layout is applied, for example, in swivel units from the Zimmer Handling Technology division.

# GENERAL TIPS AND TRICKS

## ▶ TIP 5: Two-side damping with translational movement

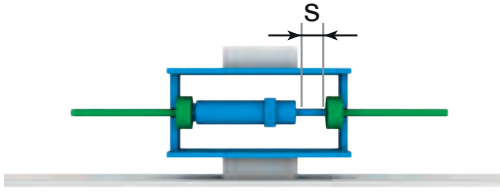

- ▶ Damping in both directions through one shock absorber.
- ▶ This device transforms a single-effect into a dual-effect shock absorber.

## ▶ TIP 7: Ideally non-elastic impact with two masses moving toward one another

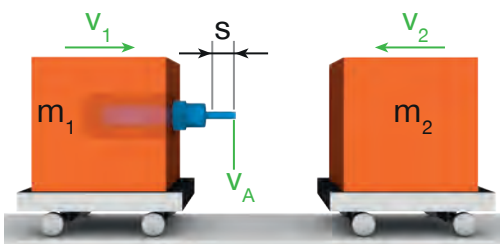

- ▶ Velocity of the entire object (both masses together) following impact:

$$v'_{12} = \frac{m_1 \cdot v_1 - m_2 \cdot v_2}{m_1 + m_2}$$

with positive sign: movement to the right  
with negative sign: movement to the left

- ▶ Calculation of energy per stroke to be damped by the damper upon impact:

$$W = \frac{1}{2} \cdot \frac{m_1 \cdot m_2}{m_1 + m_2} \cdot (v_1 + v_2)^2$$

with effect of drive forces, addition of  $W_2 = F \cdot s$

- ▶ Calculation of impact velocity through calculation of relative velocity:

$$v_A = v_1 + v_2$$

## ▶ TIP 9: Cascade connection

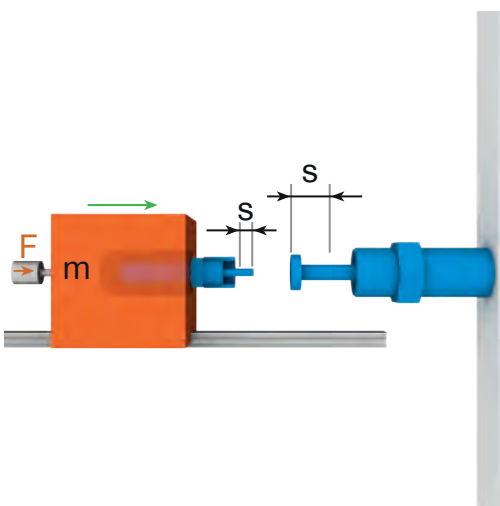

Cascade connection of a small shock absorber that impinges upon a larger shock absorber:

- ▶ Continuous operation with low energy absorption:  
The smaller shock absorber damps the energy and retracts until its stop sleeve rests on the head of the larger shock absorber, as a result of which this retracts to an insignificant extent due to its high energy absorption capacity.
- ▶ Emergency stop operation with greater energy absorption:  
The smaller shock absorber retracts quickly and transfers the load through its stop sleeve to the head of the larger shock absorber, which retracts as a result and damps the high energy.

As a result of this layout, optimal damping is guaranteed for both operating modes, although no defined end position can be ensured for continuous operation.

► **TIP 6: Two-side damping with rotational movement**

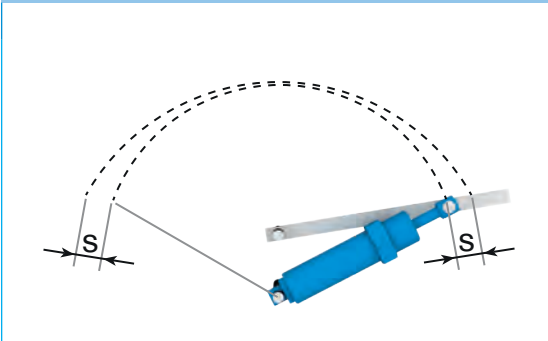

- Damping in both end positions of the rotation movement by a shock absorber.
- Due to this layout for damping both end positions, only one shock absorber is necessary.

► **TIP 8: Ideally non-elastic impact with two masses moving in the same direction**

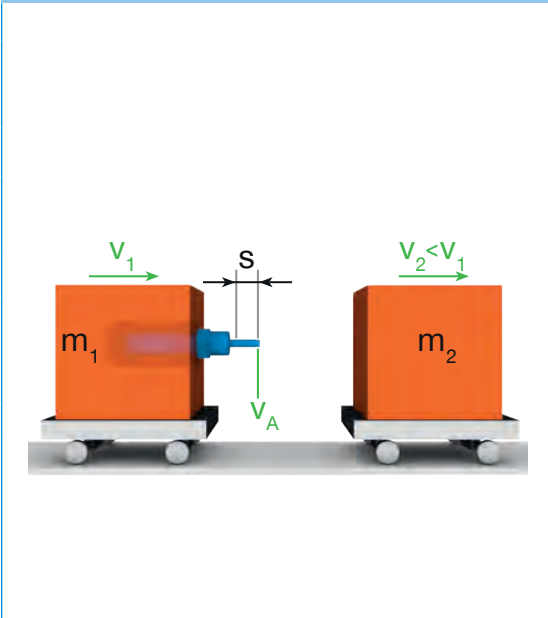

- Velocity of the entire object (both masses together) following impact:

$$v'_{12} = \frac{m_1 \cdot v_1 + m_2 \cdot v_2}{m_1 + m_2}$$

- Calculation of energy per stroke to be damped by the damper upon impact:

$$W = \frac{1}{2} \cdot \frac{m_1 \cdot m_2}{m_1 + m_2} \cdot (v_1 - v_2)^2$$

with effect of drive forces, addition of  $W_2 = F \cdot s$

- Calculation of impact velocity through calculation of relative velocity:

$$v_A = v_1 - v_2$$

- This means that a second mass, which either stands still or moves more slowly, is accelerated gently by a more quickly moving mass without resulting in a sudden increase in velocity and without the second mass recoiling or springing away.

# USAGE NOTE

## GENERAL

---

The contents of this catalog are not legally binding and are intended solely for informational purposes. Any final agreement will be in the form of a written order confirmation from Zimmer GmbH, which occurs only subject to the respective current General Terms and Conditions of Sale and Delivery of Zimmer GmbH. These can be found online at [www.zimmer-group.com](http://www.zimmer-group.com).

All of the products listed in this catalog are designed for their intended use, e.g. machines for automation. The recognized technical regulations for safety and professional work must be followed for use and installation.

Furthermore, the respective laws, guidelines from TÜV, guidelines from the respective trade association and VDE stipulations shall apply.

The technical data listed in this catalog must be observed by the user. The user must not exceed or fail to meet the specified data. If that information is missing, it cannot be assumed that there are no upper or lower limits or no limitations for specific use cases. For unusual applications, please always consult us for advice.

Disposal is not included in the price and would have to be taken into account if Zimmer GmbH were to take back and dispose of the equipment.

### TECHNICAL DATA AND FIGURES

The technical data and figures have been compiled with great care and to the best of our knowledge. We cannot guarantee that the information is up to date, correct and complete.

The specifications and information, such as figures, drawings, descriptions, dimensions, weights, materials, technical and other performance data and the described products and services that are contained in general product descriptions, Zimmer GmbH catalogs, brochures and price lists in any form are subject to change and may be modified or updated at any time without prior notification. They are binding only to the extent expressly specified in a contract or order confirmation. Slight deviations from such descriptive product information shall be considered approved and shall not affect fulfillment of agreements insofar as they are reasonable for the customer.

### LIABILITY

Products from Zimmer Group are subject to the German Product Liability Act. This catalog does not contain any guarantees, assurances of quality or procurement agreements for the products it depicts, neither expressly nor implied, including for the availability of products. Advertising statements regarding quality features, properties or applications of the products are not legally binding.

To the extent permitted by law, Zimmer GmbH is exempt from any liability for direct or indirect damage, subsequent damage and requests of any kind or on any legal basis resulting from the use of information contained in this catalog.

### TRADEMARK, COPYRIGHT AND REPRODUCTION

The depiction of commercial property rights in this catalog, such as brands, logos, registered trademarks or patents, does not include the granting of licenses or use rights. Their use is not permitted without the express written agreement of Zimmer GmbH. All contents of this catalog are the intellectual property of Zimmer GmbH. For the purposes of copyright, any unlawful use of intellectual property, including excerpts, is prohibited. Reprinting, copying or translating (including in the form of excerpts) are permitted only with the prior written consent of Zimmer GmbH.

### STANDARDS

Zimmer Group has a quality management system certified in accordance with ISO 9001:2008. Zimmer Group has an environmental management system certified in accordance with ISO 14001:2004.



# USAGE NOTE

## INDIVIDUAL

---

### INDIVIDUAL „INDUSTRIAL DAMPING TECHNOLOGY“ – DIRECTIVES, LAWS AND STANDARDS

#### Harmonized EU directives

The products of the Zimmer Group comply with the standardized and harmonized directives and standards of the European Union, which apply to products for the EU single market.

#### CE-relevant harmonized EU directives:

The industrial shock absorbers from the Zimmer Group meet the requirements of the respective harmonized EU directives, as long as they are relevant to them. However, the following guidelines do not define a scope of validity for industrial shock absorbers:

- ▶ In accordance with the Machinery Directive, industrial shock absorbers are components for installing in machines, which means neither a EC Declaration of Conformity nor a EC Type Examination are required. In addition, no Manufacturer's Declaration is needed either.
- ▶ As per the Pressure Equipment Directive, industrial shock absorbers are components with a low potential for danger, which is why they are omitted from this scope of validity.
- ▶ Other harmonized directives contained in the German Equipment and Product Safety Act do not apply for general mechanical engineering application as components. For example, the directives for elevators, ropeways and medical products as well as the ATEX explosion protection directive require a corresponding application of shock absorbers in this area. However, this does not correspond to general use. Instead, they represent special applications that are subject to a separate directive review.
- ▶ Consequently, no general mandatory CE markings exist for the industrial shock absorbers from the Zimmer Group for general use in mechanical engineering, which is why they are not inspected in the relevant certification processes and, therefore, are not provided with the CE marking.

#### Other harmonized EU directives:

Waste Electrical and Electronic Equipment Directive (WEEE) and the Restriction of Hazardous Substances directive (RoHS) are also not relevant since hydraulic shock absorbers are not electrical or electronic devices. However, the products can be oriented to the respective ordinances.

## ZIMMER GROUP – THE KNOW-HOW FACTORY

OUR KNOW-HOW FACTORY WORKS WITH ALL INDUSTRIES AND DELIVERS EVERYTHING FROM A SINGLE SOURCE. OUR PRODUCT RANGE IS FAR REACHING, BOTH IN ITS DEPTH AND ITS BREADTH.

DO YOU HAVE A DEVELOPMENT PROBLEM? WE'LL SOLVE IT! SET US A CHALLENGE IN RESEARCH AND DEVELOPMENT. COUNTLESS INNOVATIONS ORIGINATE FROM OUR COMPANY. WE ARE ENTHUSIASTIC ABOUT NEW PRODUCTS AND PRIDE OURSELVES ON OUR CORPORATE PIONEERING SPIRIT.

### CONTACT – WORLDWIDE

With our current 13 global subsidiaries and partners in over 125 countries, we offer the excellent service of a technology leader. We look forward to hearing from you!

[www.zimmer-group.com/en-us/contact](http://www.zimmer-group.com/en-us/contact)



### ZIMMER GROUP SYSTEM TECHNOLOGY – THE SPECIALISTS FOR CUSTOM SOLUTIONS

With over 30 years of development experience, the system technology develops special solutions for handling and automation.

[www.zimmer-group.com/en-us/system-technology](http://www.zimmer-group.com/en-us/system-technology)



### HERE FOR YOU 24/7/365 – OUR VIRTUAL TRADE SHOW BOOTH

With impressive features such as an animated camera flight, clickable information hotspots and 3D models that can be rotated, we guarantee that you will be thrilled—virtually.

[www.zimmer-group.com/en-us/expo](http://www.zimmer-group.com/en-us/expo)



### OUR NEW PRODUCTS

Zimmer Group is renowned as an innovator and for its pioneering spirit. Accordingly, each year we can offer new innovative and individual solutions. For current product highlights, refer to:

[www.zimmer-group.com/en-us/innovations](http://www.zimmer-group.com/en-us/innovations)



HEADQUARTER:  
**ZIMMER GROUP**  
Am Glockenloch 2  
DE 77866 Rheinau  
T +49 7844 9139-0  
F +49 7844 9139-1199  
info.de@zimmer-group.com  
[www.zimmer-group.com](http://www.zimmer-group.com)